





*Honesty
& Dedication*
are our **principles**

When the finishing touch calls for a truly special design, we provide full-service made-to-order services for any product, from finials to rods to tiebacks in all sizes, shapes, finishes and materials.

Whether you have a custom blueprint design that's ready for production or a rough pencil sketch, our expert, friendly staff is equipped with solid technical knowledge and creative inspiration to help guide you from start to finish.

Your creative goals will be met, your item ready on time, and most importantly, your clients will be impressed with the look and feel of their enhanced surroundings.





Wrought Iron

- Rod Styles and Sizes 2
- 5th Avenue Crystal Finial Collection 3
- Contempo Finial Collection 4
- Manhattan Finial Collection 5
- Metropolis Finial Collection 6
- Urban Finials / Petite finials 7
- Traditional Finial Collection 8
- Royal Finial Collection 11
- Renaissance Collection 12
- Tiebacks / Swag Holders 14

Accessories & Brackets

- Corner Bracket, Rings, etc. 17
- Hand Forged Brackets 18
- Hand Crafted & Contempo Brackets 19
- Signature Brackets Manhattan, Urban & Regal.... 20
- Urban & French Rods with Returns 22
- Urban Slim Collection 23
- Urban Slim Brackets & Bypass System 25

Plated Collections

27

Rod Styles, Monaco, Crystal, Contempo, Manhattan, Urban Finials, Tiebacks, Accessories, Hand Crafted Brackets, Signature Brackets, Urban & French Rods with Returns, Urban Slim Rods, Urban Slim Finials, Urban Acrylic Rods & Urban Acrylic Finials.

Traversing Systems

42

Somfy Motorized Traverse System, Demi-Traverse Rods, Euro Traverse Rods.

Wood And Resin Collection, Artisan Rods

51

Wood Collection, Resin Collection, Cornices and Crowns, Artisan Rods, Swing Arms, Swift Program, Designer's Tools & Finishes.

rod styles *rod styles*

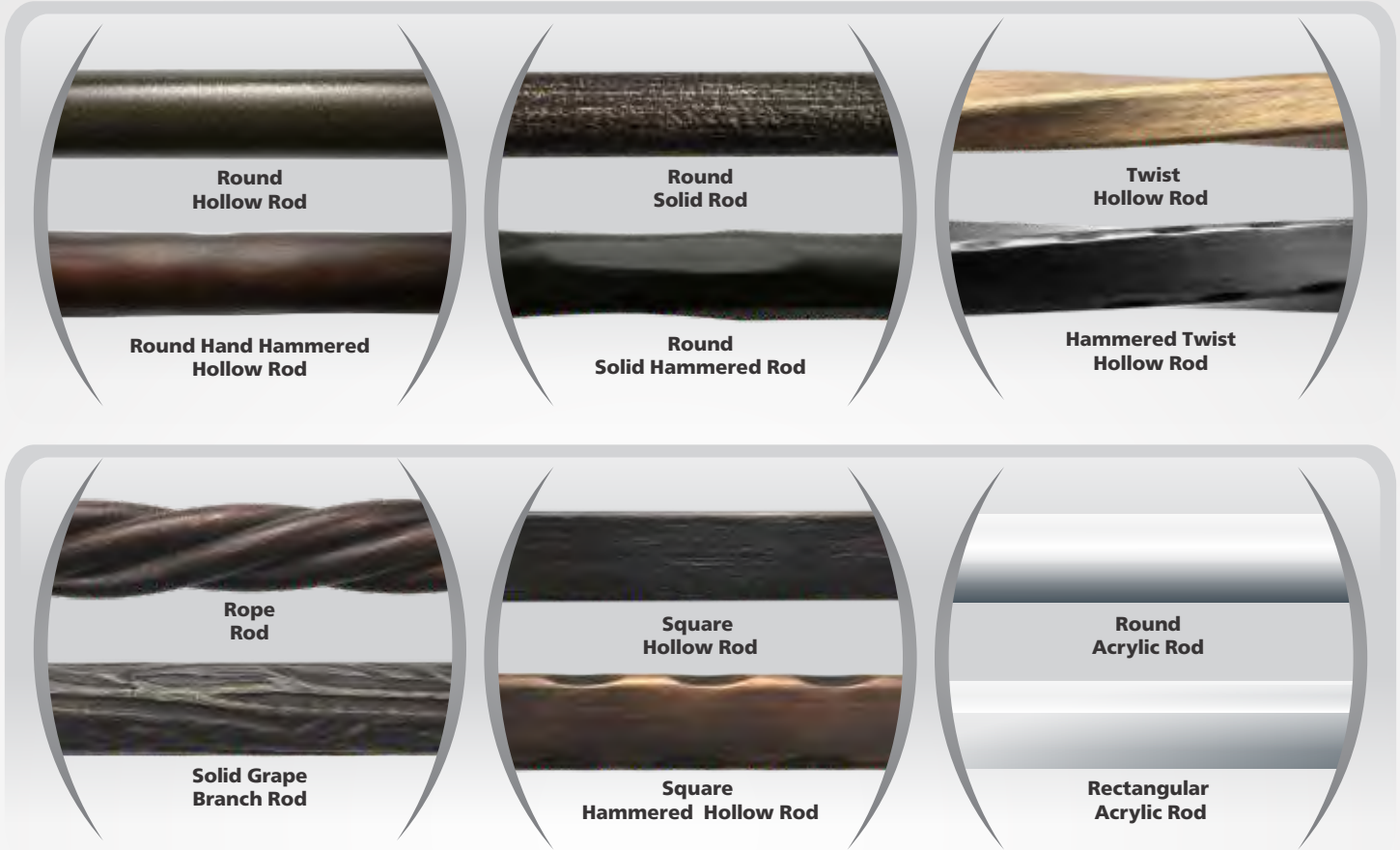

rod sizes

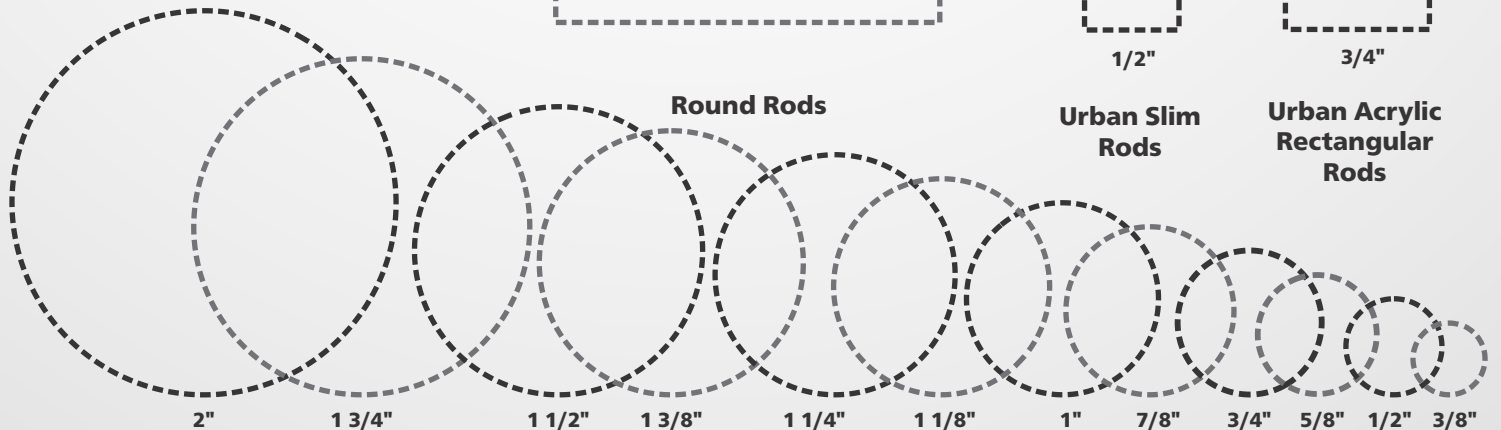
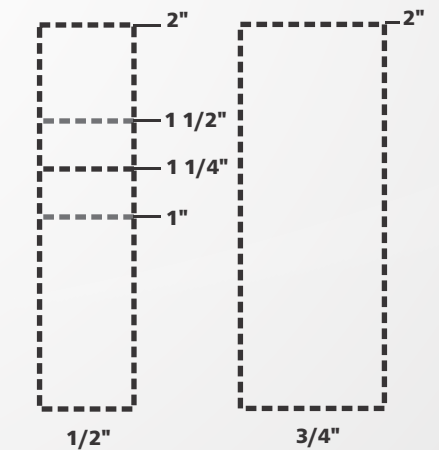
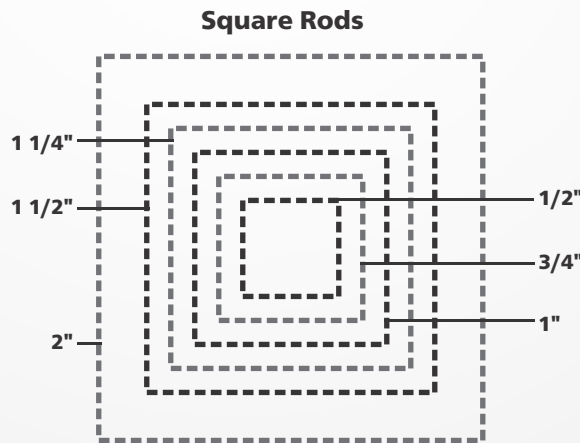
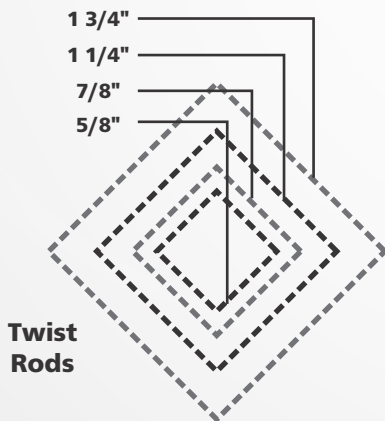

5th avenue collection *finials*

F

crystal collection



• All finials can be utilized as tiebacks.

contempo finial collection



manhattan finial collection



60
L 4" x H 1 3/4"
Verdy Vecchio: Grp3

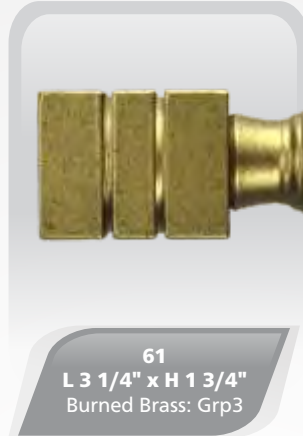

61
L 3 1/4" x H 1 3/4"
Burned Brass: Grp3

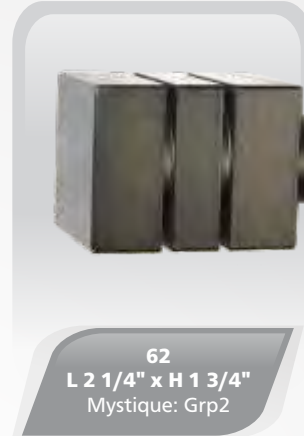

62
L 2 1/4" x H 1 3/4"
Mystique: Grp2

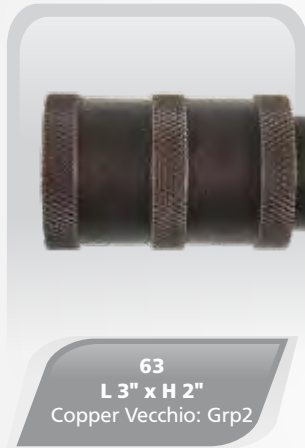

63
L 3" x H 2"
Copper Vecchio: Grp2

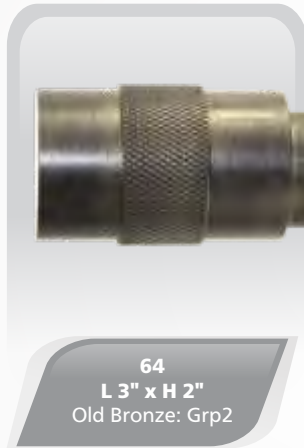

64
L 3" x H 2"
Old Bronze: Grp2



65
L 3" x H 2"
Raw Steel: Grp2



66
L 3" x H 2"
Dark Steel: Grp2

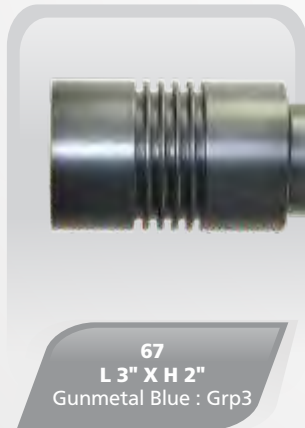

67
L 3" X H 2"
Gunmetal Blue : Grp3

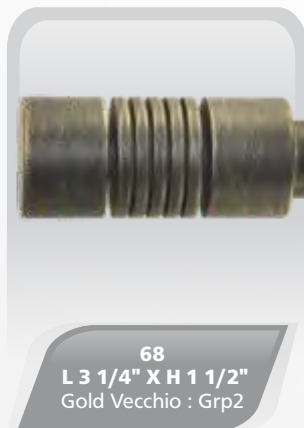

68
L 3 1/4" X H 1 1/2"
Gold Vecchio : Grp2

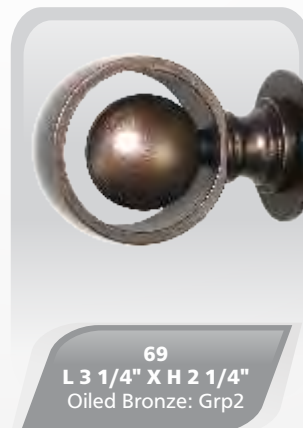

69
L 3 1/4" X H 2 1/4"
Oiled Bronze: Grp2



70
L 3" X H 2"
Black Nickel: Grp2

• All finials can be utilized as tiebacks.



*10
L 3 1/2" x H 2 1/2"
Raw Steel: Grp2

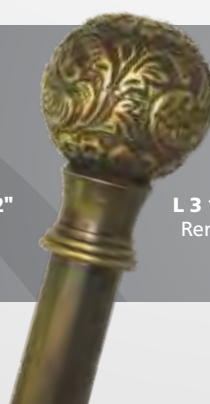

*14
L 3 1/4" x H 2 1/4"
Renaissance: Grp3



*15
L 3 1/4" X H 2 1/2"
Black Nickel : Grp2



*17
L 3 1/2" X H 2 1/2"
Cava : Grp2

*While supplies last.

metropolis finial collection

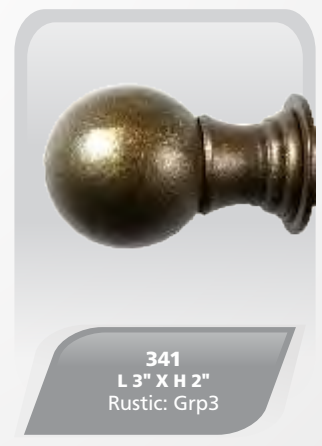
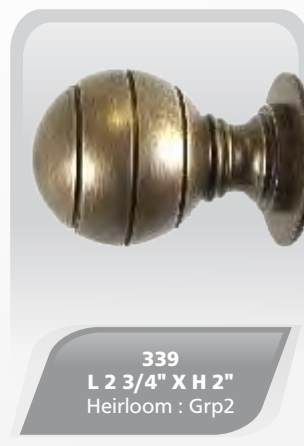
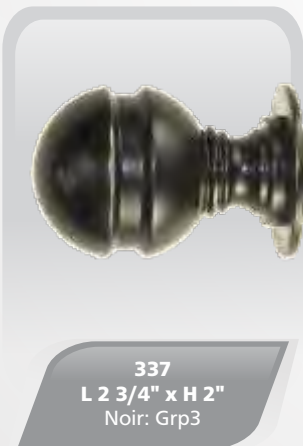
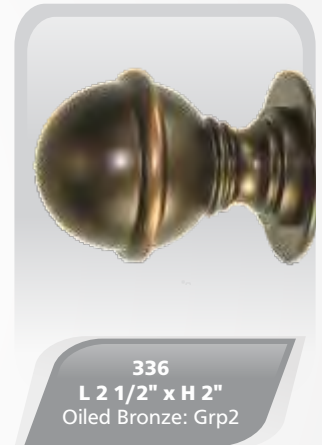
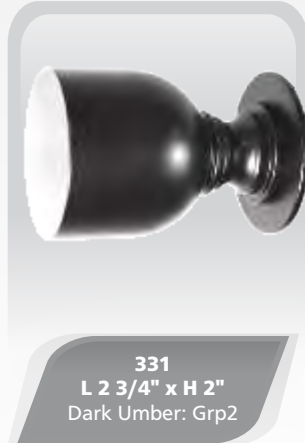
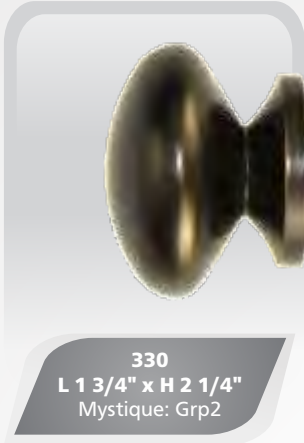

• All finials can be utilized as tiebacks.

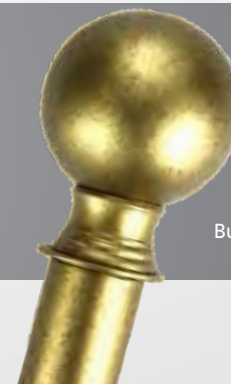

finials



urban finials

• All finials can be utilized as tiebacks.



Urban Slim Finials 680 to 687 are available for Urban Slim Rods 1" to 2" as well as Iron Round Rods from 1" to 2" Diameter.



petite finials

80
L 4 5/8" x H 3"
White: Grp2

81
L 4 1/2" x H 2 1/2"
Old Bronze: Grp2

82
L 4 1/2" x H 1 3/8"
Dusty Gold: Grp2

83
L 4 1/4" x H 2"
Dark Umber: Grp2

84
L 3" x H 1 3/8"
Olive: Grp3

85
L 1 5/8" x H 1 1/8"
Gold Vecchio: Grp2



traditional finial collection



100
Left/Right
L 4 1/2" x H 3 1/4"
Dark Umber: Grp2



101
L 6 1/2" x H 5"
Enigma: Grp2

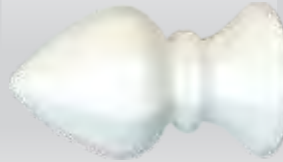

103
L 3 1/2" x H 2"
White: Grp2



104
L 4 1/4" x H 3 3/4"
Mystique: Grp2



105
L 3 1/4" x H 3"
Old Bronze: Grp2



106
L 5 1/4" x H 4"
Gold Vecchio: Grp2



107
L 4" x H 1"
Red Oxide: Grp2



108
L 2 1/2" x H 2"
Radiant Gold: Grp2



109
L 5" x H 2 3/4"
Heirloom: Grp2



110
L 3 1/4" x H 2 1/4"
Olive: Grp3

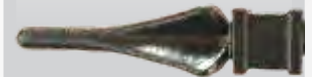

111
L 4" x H 1"
Dark Steel: Grp2

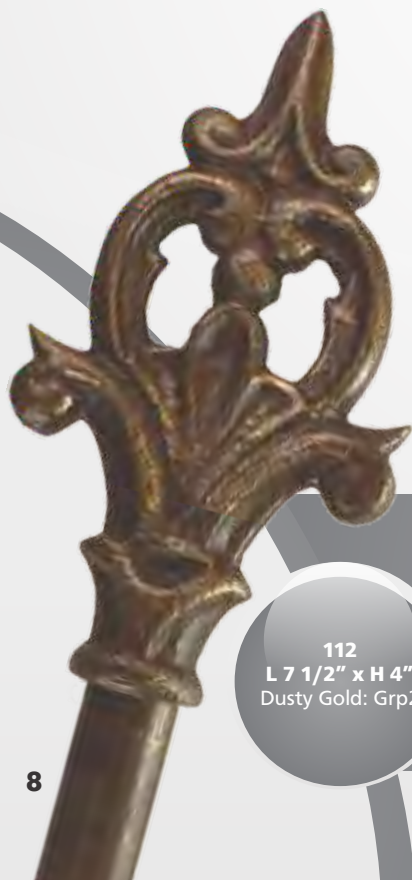

112
L 7 1/2" x H 4"
Dusty Gold: Grp2



113
L 5" x H 2"
Heirloom: Grp2



114
L 2" x H 2 1/4"
Mystique: Grp2

• All finials can be utilized as tiebacks.

finials

F

traditional finial collection

• All finials can be utilized as tiebacks.



115
L 3 1/2" x H 2 1/2"
White: Grp2

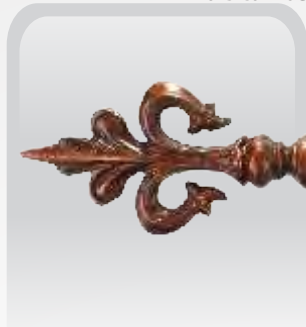

116
L 7 1/2" x H 4"
Merlot: Grp2

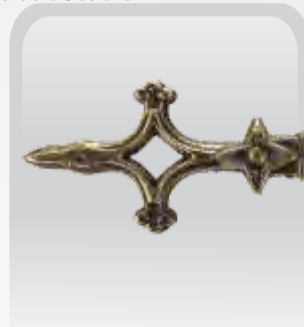

117
L 6" x H 3 1/4"
Gold Vecchio: Grp2

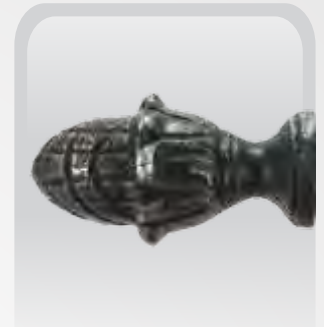

118
L 4" x H 2 1/4"
Rusted Black: Grp3

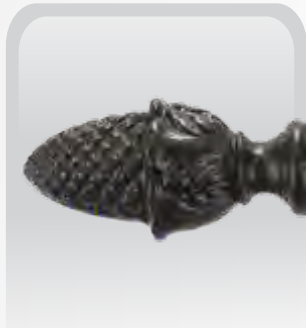

119
L 5 1/4" x H 2 3/4"
Dark Umber: Grp2

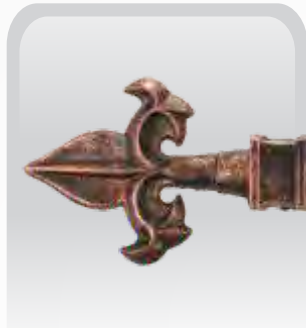

120
L 4 3/4" x H 3"
Copper Vecchio: Grp2



121
L 7 1/2" x H 2 1/2"
Cava: Grp2



*122
Left/Right/Hand Crafted
L 11 1/2" x H 11"
Olive: Grp3



*123
Left/Right/Hand Crafted
L 4 1/2" x H 4 3/4"
Oiled Bronze: Grp2

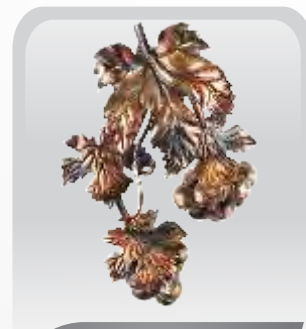

*124
Left/Right/Hand Crafted
L 5 1/4" x H 9 1/2"
Oiled Bronze: Grp2

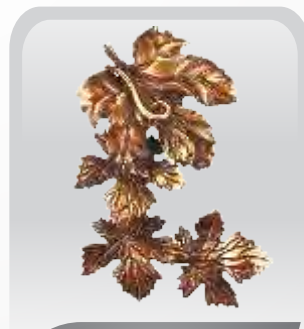

*125
Hand Crafted
L 5 1/2" x H 7 1/2"
Enigma: Grp2



130
L 2 1/4" x H 1 1/4"
Vintage: Grp3



126
L 1 3/4" x H 1 1/4"
Black Nickel: Grp2

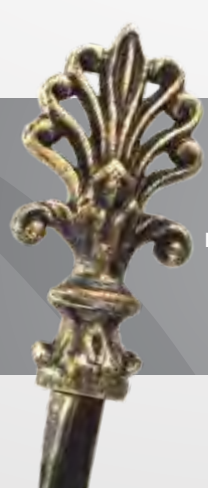

128
L 5 1/4" x H 2 1/2"
Gold Vecchio: Grp2



129
L 2 3/4" x H 1 1/2"
Merlot: Grp2



*While Supplies Last

traditional finial collection



131
L 4 3/4" x H 3"
Plume: Grp3

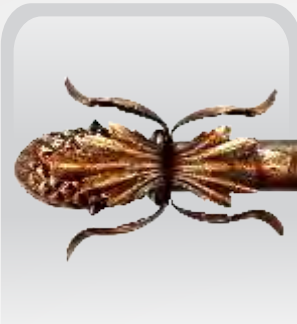

132
L 5 1/2" x H 3"
Flare: Grp3

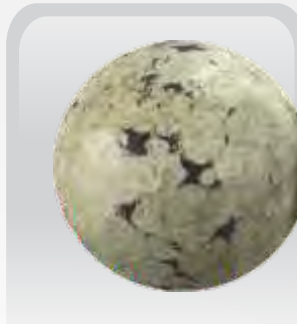

133-3"
Hand Hammered
3" Diameter
Old Country: Grp3



134-2"
2" Diameter
Burned Brass: Grp3



135
3" Diameter
Noir: Grp3

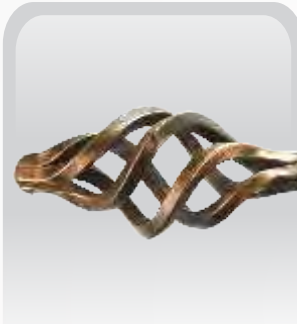

136
L 6" x H 3"
Verdy Vecchio: Grp3



137
L 5" x H 2 1/2"
Renaissance: Grp3



*138
L 3" x H 3"
Burnt Sienna: Grp3



*139
L 3" x H 3"
Tarnished Brown: Grp3

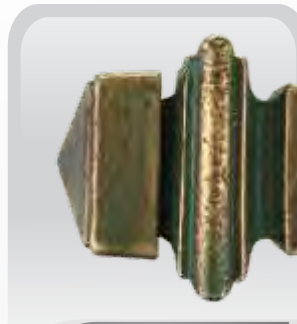

140
L 2 1/2" x H 2 1/2"
Renaissance: Grp3

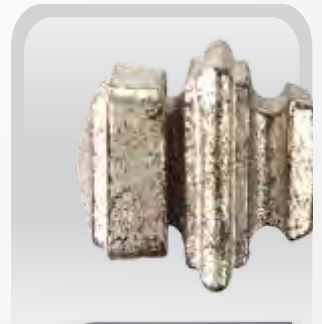

141
L 2 1/4" x H 2 1/4"
Plume: Grp3



142
L 3/4" x H 2"
Verdy Vecchio: Grp3

• All finials can be utilized as tiebacks.

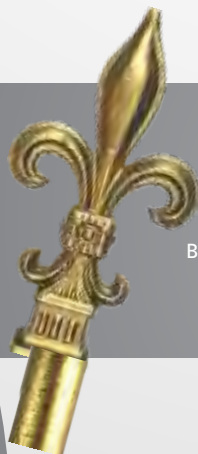

143
L 9" x H 5"
Burned Brass: Grp3

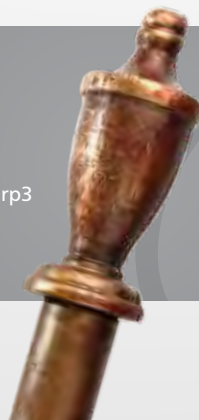

144
L 4" x H 1 1/2"
Flare: Grp3



145
L 5" x H 3 1/2"
Burned Brass: Grp3

*While Supplies Last

royal finial collection



165
L 5" x H 3 3/4"
Verdy Vecchio: Grp3

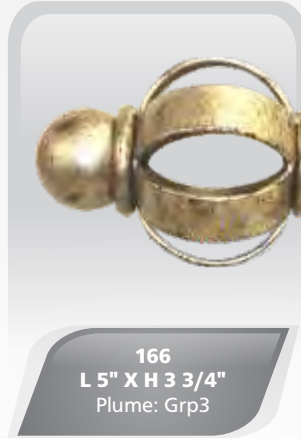

166
L 5" x H 3 3/4"
Plume: Grp3

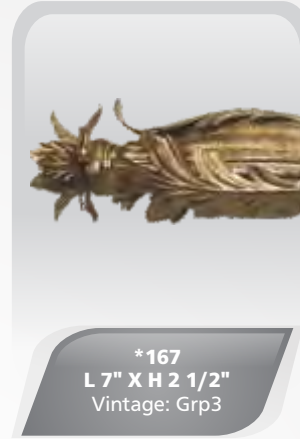

*167
L 7" x H 2 1/2"
Vintage: Grp3

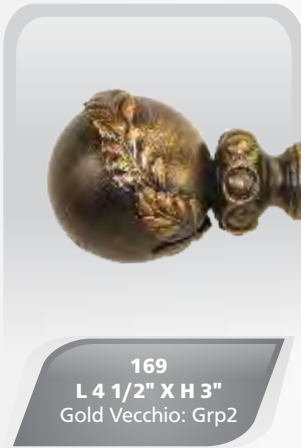

169
L 4 1/2" x H 3"
Gold Vecchio: Grp2

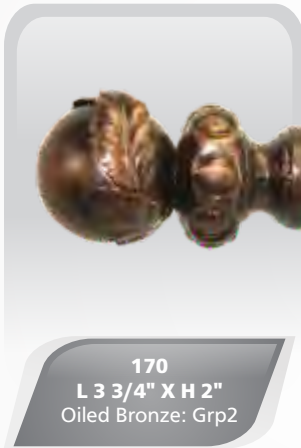

170
L 3 3/4" x H 2"
Oiled Bronze: Grp2

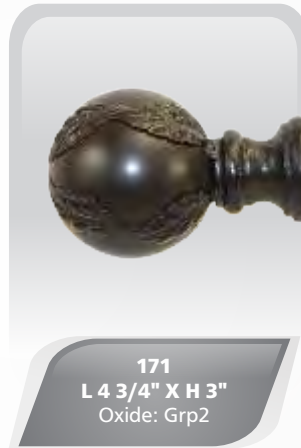

171
L 4 3/4" x H 3"
Oxide: Grp2

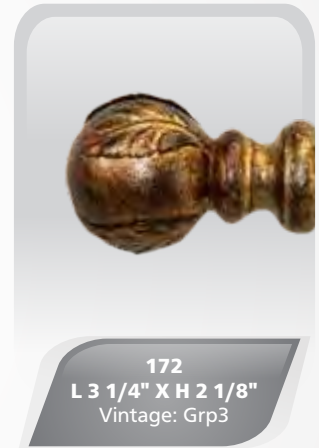

172
L 3 1/4" x H 2 1/8"
Vintage: Grp3

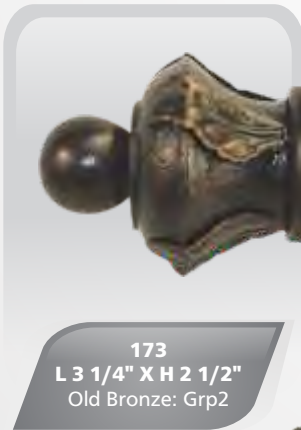

173
L 3 1/4" x H 2 1/2"
Old Bronze: Grp2

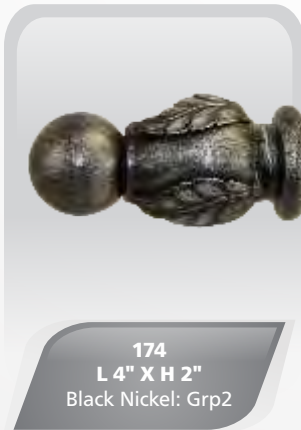

174
L 4" x H 2"
Black Nickel: Grp2

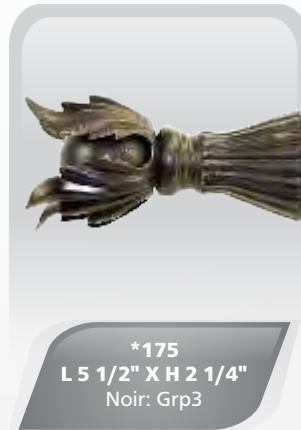

*175
L 5 1/2" x H 2 1/4"
Noir: Grp3



178
L 4" x H 3 1/2"
Dark Umber: Grp2

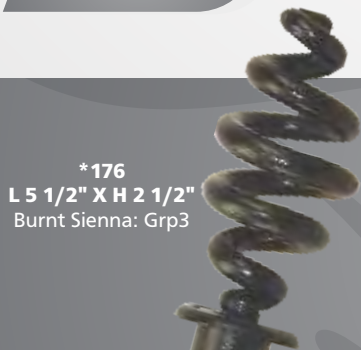

*176
L 5 1/2" x H 2 1/2"
Burnt Sienna: Grp3



*177
L 5 1/2" x H 3 1/2"
Rustic: Grp3

*While Supplies Last

• All finials can be utilized as tiebacks.

renaissance finial collection

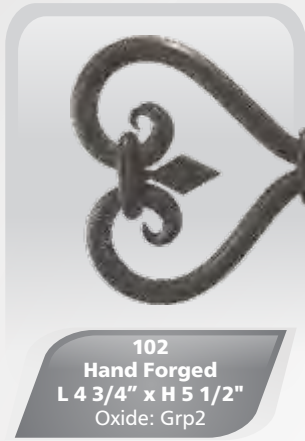

102
Hand Forged
L 4 3/4" x H 5 1/2"
Oxide: Grp2

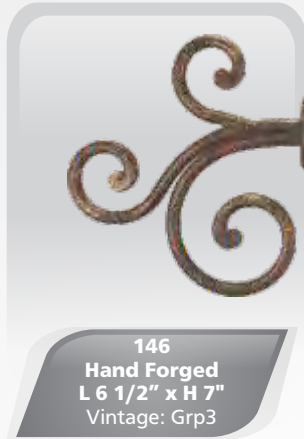

146
Hand Forged
L 6 1/2" x H 7"
Vintage: Grp3

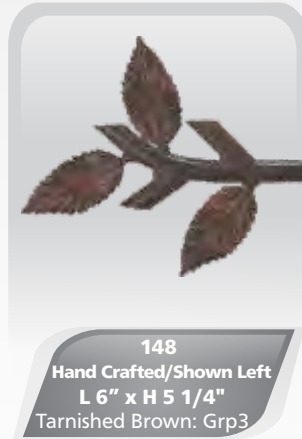

148
Hand Crafted/Shown Left
L 6" x H 5 1/4"
Tarnished Brown: Grp3

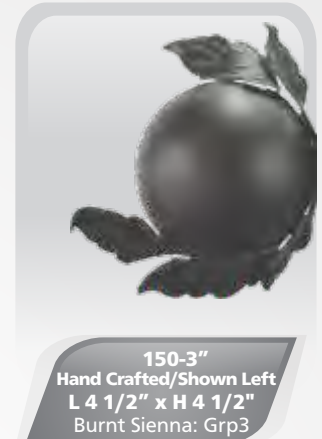

150-3"
Hand Crafted/Shown Left
L 4 1/2" x H 4 1/2"
Burnt Sienna: Grp3

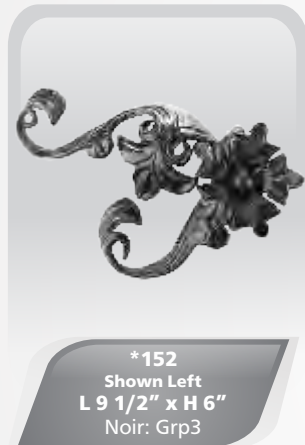

***152**
Shown Left
L 9 1/2" x H 6"
Noir: Grp3

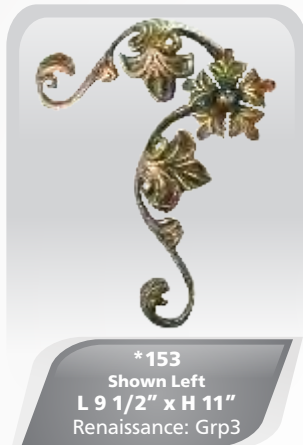

***153**
Shown Left
L 9 1/2" x H 11"
Renaissance: Grp3

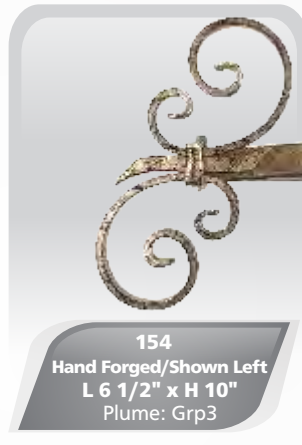

154
Hand Forged/Shown Left
L 6 1/2" x H 10"
Plume: Grp3

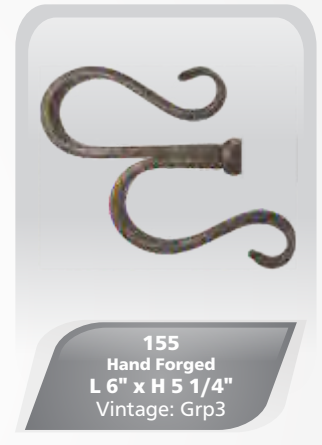

155
Hand Forged
L 6" x H 5 1/4"
Vintage: Grp3

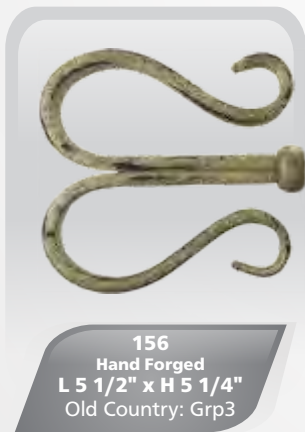

156
Hand Forged
L 5 1/2" x H 5 1/4"
Old Country: Grp3

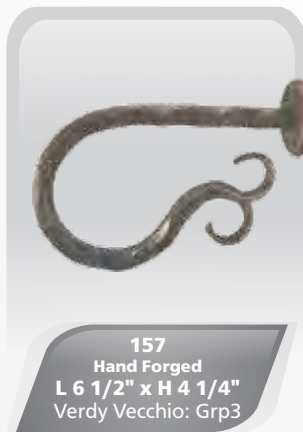

157
Hand Forged
L 6 1/2" x H 4 1/4"
Verdy Vecchio: Grp3

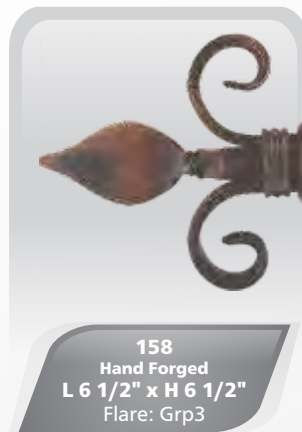

158
Hand Forged
L 6 1/2" x H 6 1/2"
Flare: Grp3



159
Hand Forged/Shown Left
L 6 3/4" x H 6"
Tarnished Brown: Grp3

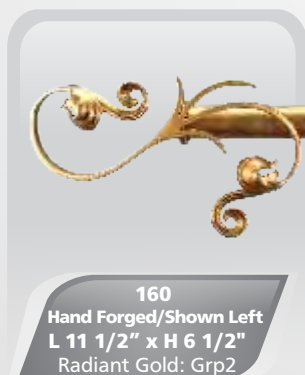

160
Hand Forged/Shown Left
L 11 1/2" x H 6 1/2"
Radiant Gold: Grp2

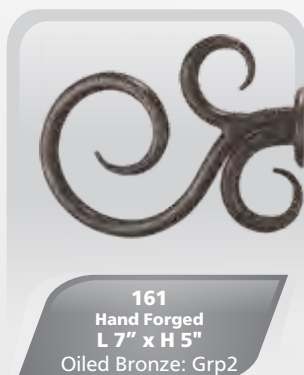

161
Hand Forged
L 7" x H 5"
Oiled Bronze: Grp2



162
Hand Forged
L 7 1/2" x H 4"
Old Bronze: Grp2

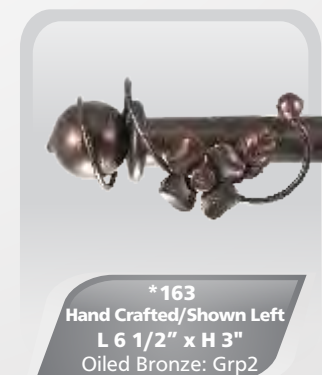

***163**
Hand Crafted/Shown Left
L 6 1/2" x H 3"
Oiled Bronze: Grp2

finials *finials*

F

renaissance finial collection

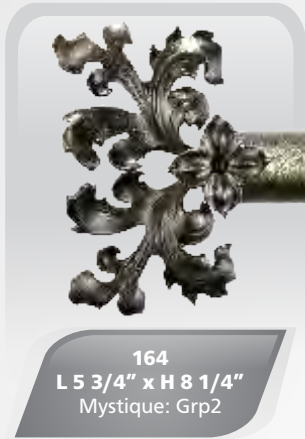

164
L 5 3/4" x H 8 1/4"
Mystique: Grp2

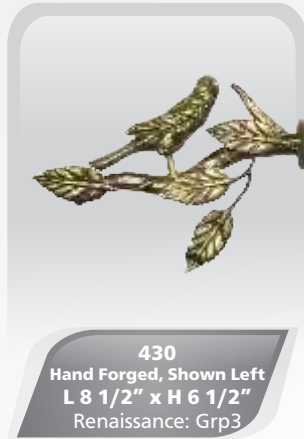

430
Hand Forged, Shown Left
L 8 1/2" x H 6 1/2"
Renaissance: Grp3

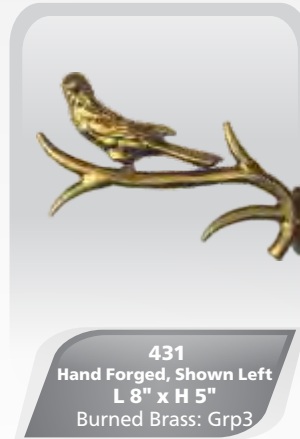

431
Hand Forged, Shown Left
L 8" x H 5"
Burned Brass: Grp3



*432
Shown Left
L 8 1/4" x H 8 1/2"
Mystique: Grp2

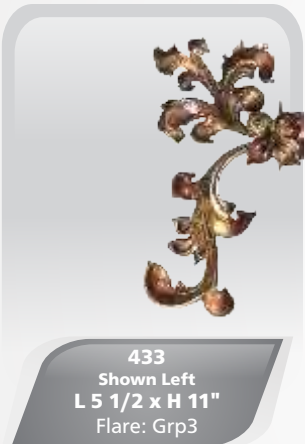

433
Shown Left
L 5 1/2" x H 11"
Flare: Grp3

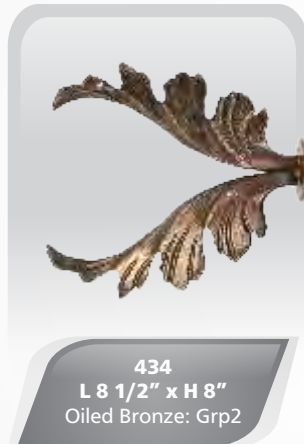

434
L 8 1/2" x H 8"
Oiled Bronze: Grp2

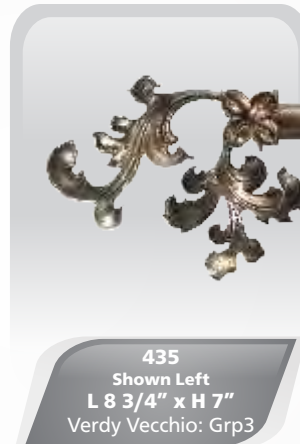

435
Shown Left
L 8 3/4" x H 7"
Verdy Vecchio: Grp3

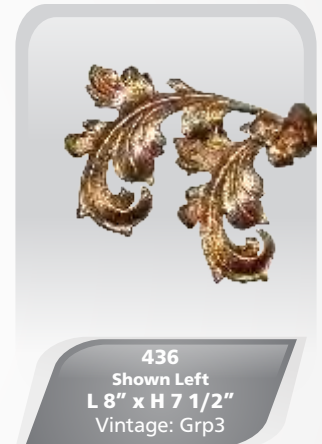

436
Shown Left
L 8" x H 7 1/2"
Vintage: Grp3

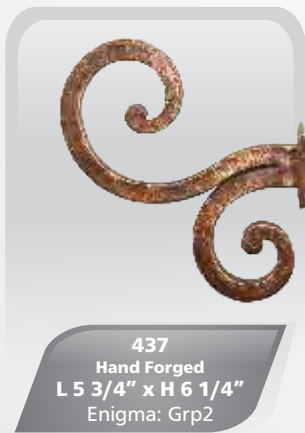

437
Hand Forged
L 5 3/4" x H 6 1/4"
Enigma: Grp2

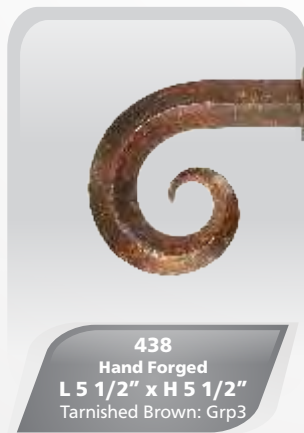

438
Hand Forged
L 5 1/2" x H 5 1/2"
Tarnished Brown: Grp3

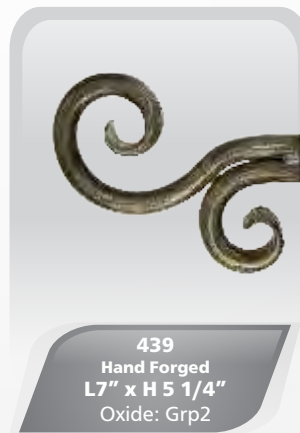

439
Hand Forged
L 7" x H 5 1/4"
Oxide: Grp2

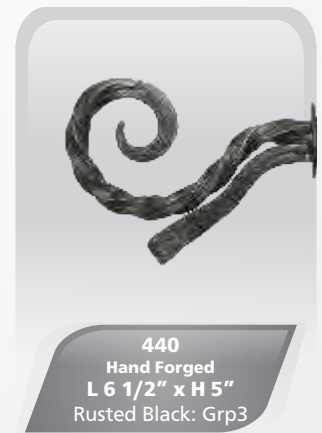

440
Hand Forged
L 6 1/2" x H 5"
Rusted Black: Grp3

• All finials can be utilized as tiebacks.



441
Hand Forged
Shown Left
L 5 1/2" x H 4 1/4"
White: Grp2

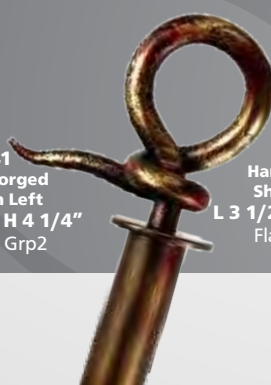

442
Hand Forged
Shown Left
L 3 1/2" x H 2 1/2"
Flare: Grp3

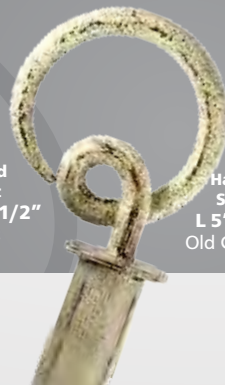

443
Hand Forged
Shown Left
L 5" x H 4 3/4"
Old Country: Grp3

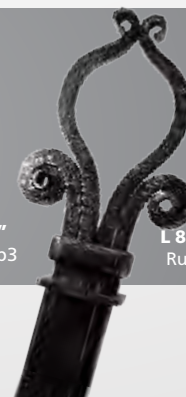

444
Hand Forged
L 8 1/4" x H 5 1/2"
Rusted Black: Grp3



445
Hand Forged
L 7" x H 9"
Renaissance : Grp3

tiebacks *tiebacks*



700
L 4" x H 9 1/2"
Renaissance: Grp3



701
L 3" x H 6 1/4"
Burned Brass: Grp3



702
L 3 3/4" x H 6"
Noir: Grp3



703
L 6" x H 6"
Old Country: Grp3



704
L 4" x H 5 3/4"
Plume: Grp3



705
L 4 1/2" x H 4 1/2"
Verdy Vecchio: Grp3



706
L 3 1/2" x H 6 1/4"
Burned Brass: Grp3



707
L 2 1/2" x H 6 1/4"
Enigma: Grp2



708
L 3 3/4" x H 4"
Burnt Sienna: Grp3



709
3 1/2" Diameter
Tarnished Brown: Grp3



710
L 2 3/4" x H 4 3/4"
Old Country: Grp3



711
3" Diameter
Flare: Grp3



712
3 1/2" Diameter
Plume: Grp3

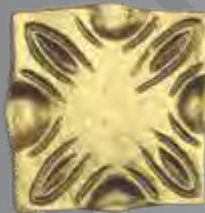

713
L 3 1/2" x H 3 1/2"
Burned Brass: Grp3



714
Shown Right
L 8 1/2" x H 4"
Burned Brass: Grp3



715
L 5" x H 4 1/2"
Vintage: Grp3

tiebacks *tiebacks*

T



716
L 4 1/2" x H 4 1/2"
Burned Brass: Grp 3



718
3 1/2" Diameter
Burnt Sienna: Grp 3



720
L 5" x H 2 1/2"
Renaissance: Grp 3



723
L 4 1/2" x H 6 1/4"
Noir: Grp 3



724
3/4 Diameter
Old Bronze: Grp 2



725
Shown Right
L 13" x H 6 1/4"
Renaissance: Grp 3



726
Shown Right
L 4 1/2" x H 3 1/4"
Vintage: Grp 3



727
Shown as U-Shaped
L 4" x H 1"
Burnt Sienna: Grp 3



729
Hand Forged
L 6 1/2" x H 13"
Burnt Sienna: Grp 3



728
Shown as U-Shaped
L 4" x H 1"
Flare: Grp 3

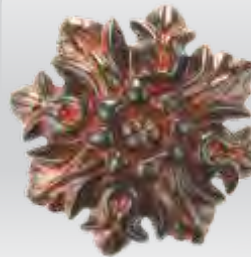

730
4 1/2" Diameter
Tarnished Brown: Grp3



731
7" Diameter
Burned Brass: Grp3



732
L 4 1/2" x H 4 1/2"
Dusty Gold: Grp2



733
3 3/4" Diameter
Mystique: Grp2



734
4 1/2" Diameter
Old Bronze: Grp2

• All tiebacks can be utilized as finials.

tiebacks *tiebacks*



735
L 6 1/2" x H 7 1/2"
Gold Vecchio: Grp2



736
L 6" x H 4 3/4"
Radiant Gold: Grp2



737
5" Diameter
Olive: Grp3



738
L 4" x H 6 1/2"
Merlot: Grp2



739
L 3 1/4" x H 5 1/4"
Heirloom: Grp2



740
L 5 3/4" x H 3"
Copper Vecchio: Grp2



741
L 3 1/2" x H 5 1/2"
Black Nickel: Grp2



742
3 1/2" Diameter
Red Oxide: Grp2



743
4" Diameter
Gold Vecchio: Grp2

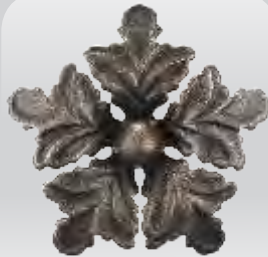

744
3 1/4" Diameter
Old Bronze: Grp2



745
3" Diameter
Radiant Gold: Grp2



752
L 2 1/4" x H 2 1/4"
Old Bronze: Grp2

contempo tiebacks & contempo batons



790
3" Diameter
Dark Steel: Grp2



792
3" Diameter
Black Nickel: Grp2

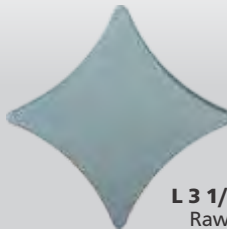

794
L 3 1/2" x H 3 1/2"
Raw Steel: Grp2



791
3" Diameter
Gold Vecchio: Grp2



793
3" Diameter
Copper Vecchio: Grp2



795
L 3 1/2" x H 3 1/2"
Raw Steel: Grp2





620
L 3 1/2 x H 5/8
Gold Vecchio: Grp2



621
L 3 1/2 x H 5/8
Burned Brass: Grp3

accessories











					
401 Corner Bracket Exterior Fit Shown in 90° Light Brown: Grp1	402 Elbow Exterior Fit Shown in 45° Light Brown: Grp1	403 Swivel Corner Bracket Interior Fit Only Brown: Grp1	404 Swivel Elbow Interior Fit Only Brown: Grp1	405 Full Socket Exterior Fit Only Radiant Gold: Grp2	406 Half Socket Exterior Fit Only Radiant Gold: Grp2
					
407 End Cap Interior Fit Radiant Gold: Grp2	407-RE Ring End Cap Interior Fit Old Bronze: Grp2	407-FE Flush End Cap Exterior Fit Gold Vecchio: Grp2	407-SQ Square End Cap Interior Fit Gold Vecchio: Grp2	408 Small Peg 2" Diameter Dusty Gold: Grp2	409 Medium Peg 2 1/2" Diameter Dusty Gold: Grp2
					
410 Hook Bracket L 3 1/2" x H 4" Black Nickel: Grp2	411 Hook Bracket L 3 1/2" x H 2 3/4" Black Nickel: Grp2	412 Hook Bracket L 3 1/2" x H 4" Black Nickel: Grp2	413 Hook 2 1/2" Long 1/4" Thickness Dark Steel: Grp2	414 Hook 2" Long 1/4" Thickness Dark Steel: Grp2	

batons / wands

							<p>AB: Acrylic Clear Baton 1/2" Diameter</p> <p>600: L 1" x H 4" Old Bronze: Grp2</p> <p>601: L 1 1/2" x H 7 1/4" Radiant Gold: Grp2</p> <p>602: L 1 1/2" x H 5" Enigma: Grp2</p> <p>603: L 1 1/2" x H 6" Oiled Bronze: Grp2</p> <p>604: L 1" x H 4" Cava: Grp2</p> <p>605: 3/4" Diameter Oxide: Grp2</p>
--	---	---	---	---	--	--	--

rings

							
500 Smooth Round Black: Grp1	502 Twist Black: Grp1	503 Hammered Black: Grp1	504 Rectangular Black: Grp1	505 Round Bypass Black: Grp1	506 Flat Round Black: Grp1	507 Flat Rectangular Black: Grp1	508 Urban Slim Black: Grp1

brackets

All brackets available in Standard 3" and 6" Projection as well as Custom Projections.

hand forged brackets



250
Hand Forged
1/2" Wide
Burnt Sienna: Grp3



251
Hand Forged
Flare: Grp3

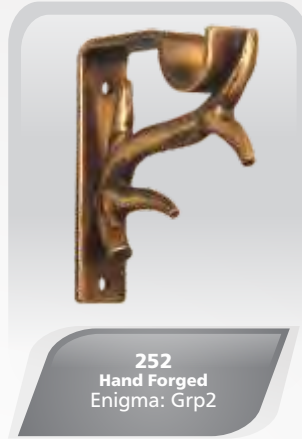

252
Hand Forged
Enigma: Grp2

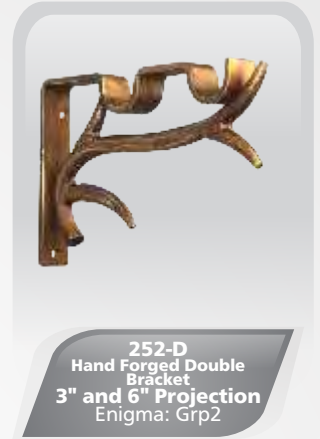

252-D
Hand Forged Double
Bracket
3" and 6" Projection
Enigma: Grp2



254
Hand Forged
Oiled Bronze: Grp2

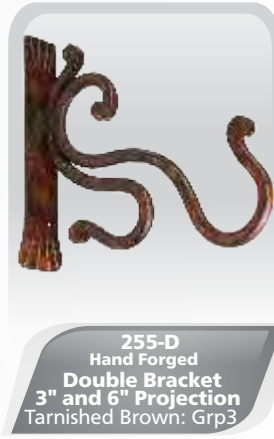

255-D
Hand Forged
Double Bracket
3" and 6" Projection
Tarnished Brown: Grp3



305
Hand Forged
Verdy Vecchio: Grp3



306
Hand Forged
White: Grp2

decorative brackets

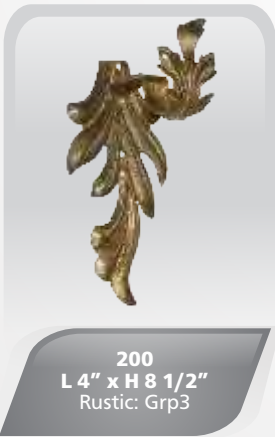

200
L 4" x H 8 1/2"
Rustic: Grp3

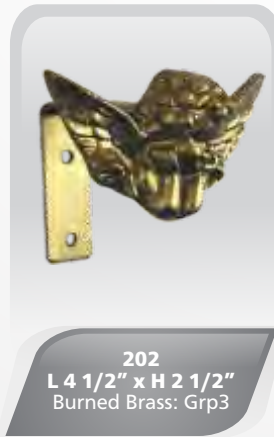

202
L 4 1/2" x H 2 1/2"
Burned Brass: Grp3

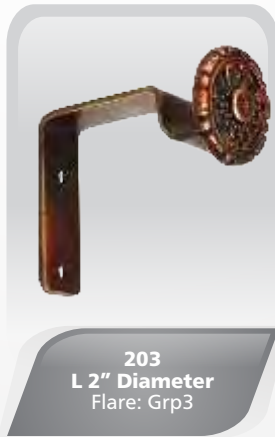

203
L 2" Diameter
Flare: Grp3

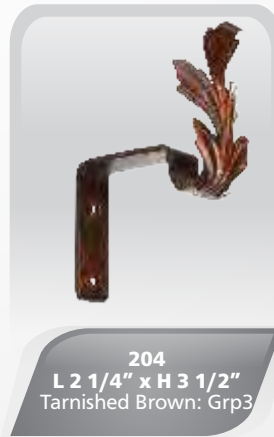

204
L 2 1/4" x H 3 1/2"
Tarnished Brown: Grp3

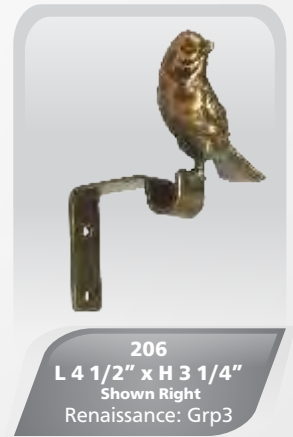

206
L 4 1/2" x H 3 1/4"
Shown Right
Renaissance: Grp3



207-3
Brown: Grp1



207-H
Horizontal Bracket
Brown : Grp1



209-3
Brown: Grp1



209-H
Horizontal Bracket
Brown: Grp1

hand crafted brackets *brackets*

304 brackets

All brackets available in standard 3" and 6" projection as well as custom projections for any rod style.



304-SP
Short Projection
1" Clearance



304-3
3" Projection



304-6
6" Projection

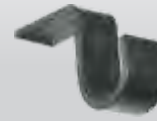

304-C
Ceiling Bracket



304-H
Horizontal Bracket



304-TS
Top Support



304-WS
With Support



304-D
Double Bracket
3" and 6" Projection

* All 304 Brackets shown in Black Grp: 1.

slim 304 brackets

All brackets available in standard 3" and 6" projection as well as custom projections for any rod style.



S304-SP
Short Projection
1" Clearance



S304-3
3" Projection
Shown for Square Rod



S304-6
6" Projection



S304-C
Ceiling Bracket



S304-H
Horizontal Bracket



S304-TS
Top Support
Shown for Square Rod



S304-WS
With Support



S304-D
Double Bracket
3" and 6" Projection

* All Slim 304 Brackets are made out of 3/4" Wide Heavy Gauge material, shown in Light Brown Grp: 1.

contempo brackets

All brackets available in standard 3" and 6" projection as well as custom projections for any rod style.



301-3
3" Projection



302-3
Invisible Screws
3" Projection



301-RECT-3
3" Projection



302-RECT-3
Invisible Screws
3" Projection



301-D
Double Bracket
3" and 6" Projection



302-D 3D
Invisible Screws
Double Bracket
3" and 6" Projection



301-RECT D
Double Bracket
3" and 6" Projection



302-RECT D 3D
Invisible Screws
Double Bracket
3" and 6" Projection

* All Contempo Brackets shown in Brown Grp: 1.

signature brackets *brackets*

manhattan brackets

All brackets available in standard 3" and 6" projection as well as custom projections for any rod style.



*Manhattan Brackets 521 and 522 Styles with Invisible Screws, all Brackets shown in Cava Grp: 2.

urban brackets invisible screws

All brackets available in standard 3" and 6" projection as well as custom projections for any rod style with invisible Screws.



*All Urban Brackets shown in Raw Steel Grp: 2.

slim urban brackets invisible screws

All brackets available in standard 3" and 6" projection as well as custom projections for any rod style with Invisible Screws.



*All Slim 304 Brackets are made out of 3/4" Wide Heavy Gauge material, shown in Radiant Gold Grp: 2.

signature brackets *brackets*



regal brackets

All Regal Brackets are available as Standard 3" Projection for Round Rods from 3/4" to 1 1/2" only, with Invisible Screws.
All Regal Brackets are available in Custom Projections.

Mix and Match any Bracket Arm with any Mounting Plate to create your Personalized Bracket.



531-TS



532-TS



533-TS



534-TS



535-TS



536-TS

*All Regal Top Support Brackets shown with Mounting Plate "D" in Burned Brass Grp: 3.
*TS : Top Support.



531



532



533



534



535



536

*All Regal Brackets shown with Mounting Plate "B" in Heirloom Grp: 2.
*For Regal Mounting Plate options "A", "B", "C" & "D" please see page 37.

regal 304 brackets

All brackets available in Standard 3" and 6" Projection as well as Custom Projections for any Rod style with Invisible Screws.



R304-A TS



R304-B TS



R304-C TS



R304-D TS



R304-A3



R304-B3



R304-C3



R304-D3



R304 A-D
Double Bracket
3" and 6" Projection



R304 B-D
Double Bracket
3" and 6" Projection



R304 C-D
Double Bracket
3" and 6" Projection



R304 D-D
Double Bracket
3" and 6" Projection

*All Regal 304 Brackets shown in Verdy Vecchio Grp: 3.
*TS: Top Support

regal mounting plates

All Regal Mounting Plates with Invisible Screws can be utilized with Urban & French Rods with Returns.



*All Regal Mounting Plates are shown in Satin Silver: Grp 2.

urban mounting plates

All Urban Mounting Plates can be utilized with Urban & French Rods with Returns.



*All Urban Mounting Plates shown in Black Nickel: Grp 2.

traditional mounting plates

All Traditional Mounting Plates can be utilized with Urban & French Rods with Returns

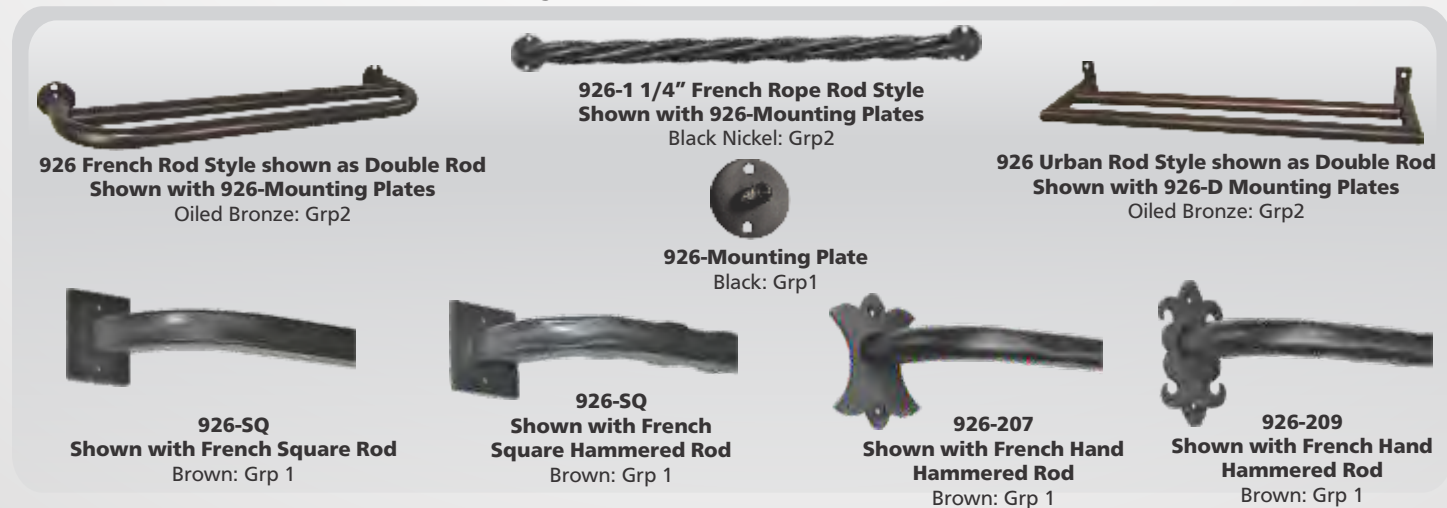

urban slim collection

R

urban slim return rods

Urban Slim Returns Rods are available on 1", 1 1/4", 1 1/2" and 2".

952-C
Shown in 1" Rod

952-Urban Slim Return Rod
Shown in 1 1/4" with Mounting Plates
952-F and 952-E
Oiled Bronze: Grp2

508 Urban Slim Ring
Black: Grp 1

952-D
Top Support
Shown in 1" Rod

952-E 3D
Shown in 1 1/4" Rod

952-F 3D
Top Support
Shown in 1 1/4" Rod

952-H
Top Support
Shown in 1 1/2" Rod

952-G
Shown in 1 1/2" Rod

*Urban Slim Mounting Plate Styles 952-E to 952-H with Invisible Screws shown in Oiled Bronze: Grp 2.

urban slim rods

Urban Slim Rods are available on 1", 1 1/4", 1 1/2" and 2".

951-2" Urban Slim Rod
Shown with Finials 646 and 647
Merlot: G2

904-1 1/2" Round Rod
Shown with Finials 686 and 687 (see page 24)
Heirloom: G2

urban slim finials

Urban Slim Finials 640 to 647 are only available for #951-2" Urban Slim Rods.

640
L 4 1/4" X H 2"
Burned Brass: Grp3

641
L 4 1/4" X H 2"
Burned Brass: Grp3

642
L 3 3/4" X H 2"
Dark Umber: Grp2

643
L 4 1/4" X H 2"
Dark Umber: Grp2

644
L 3 3/4" X H 2"
Mystique: Grp2

645
L 4 1/4" X H 2"
Mystique: Grp2

646
L 3 3/4" X H 2"
Merlot: Grp2

647
L 3 3/4" X H 2"
Merlot: Grp2

Urban Slim Finials 680 to 687 are available for Urban Slim Rods 1" to 2" as well as Iron Round Rods from 1" to 2".

680
L 5 1/4" X H 3"
Plume: Grp3

681
L 5 3/4" X H 2 3/4"
Plume: Grp3

682
L 4 1/2" X H 2 3/4"
Enigma: Grp2

683
L 4 3/4" X H 3 1/4"
Enigma: Grp2

684
L 4 1/2" X H 2 1/2"
Raw Steel: Grp2

685-Small
L 4 1/2" X H 4"
Raw Steel: Grp2

686
L 4 1/2" X H 3 3/4"
Heirloom: Grp2

687
L 4 3/4" X H 3 1/4"
Heirloom: Grp2

acrylic rods

Urban Slim Acrylic Rods 962 to 967 are available in 3 Setting finishes: Brass, Bronze and Silver ONLY.

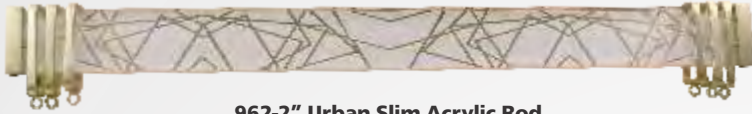

962-2" Urban Slim Acrylic Rod
Shown in Brass Setting with 508 Rings & 407-FE End Caps
in Bright Brass G2.



963-2" Urban Slim Acrylic Rod
Shown in Brass Setting with 508 Rings & 407-FE Caps
in Bright Brass G2.



964-2" Urban Slim Acrylic Rod
Shown in Bronze Setting with 508 Rings & 407-FE End Caps
in Merlot G2.

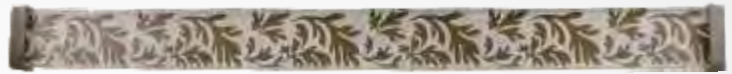

965-2" Urban Slim Acrylic Rod
Shown in Bronze Setting with 508 Rings & 407-FE End Caps
in Merlot G2.



966-2" Urban Slim Acrylic Rod
Shown in Silver Setting with 508 Rings & 1566-FE End Caps
in Polished Nickel P2

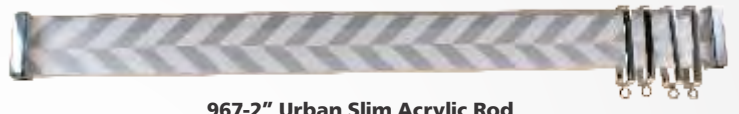

967-2" Urban Slim Acrylic Rod
Shown in Silver Setting with 508 Rings & 1566-FE End Caps
in Polished Nickel P2



960 -2" Urban Slim Acrylic Rod
Shown with Finials A686 and A687
Oiled Bronze: Grp2

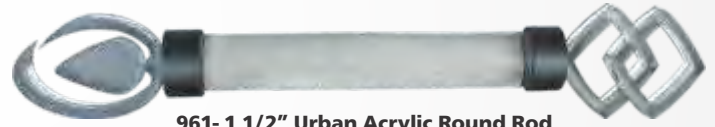

961- 1 1/2" Urban Acrylic Round Rod
Shown with Finials A682 and A683 with
Metal Silhouette.
Raw Steel: Grp2

urban slim acrylic finials

Urban Slim Acrylic Finials A640 to A647 are available with Optional Metal Silhouette for Urban Slim Acrylic Rods only.

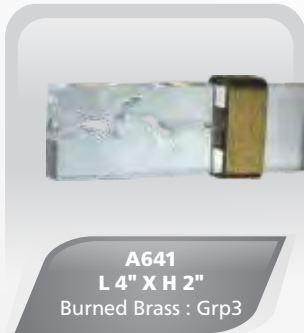

urban slim collection

F

urban acrylic finials

Urban Acrylic finials #A680 through A687 can be utilized with Urban Slim Acrylic Rods, 1 1/2" Acrylic Round rod & 1 1/4" through 2" Iron Round Rods.



urban slim brackets

Brackets available in Standard 3" and 6" Projection as well as Custom Projections for Urban Slim Rods only.



bypass system



index plated collections |

table of contents

Plated Collection

- Rod Styles and Sizes..... 27
- Monaco Finial Collection..... 28
- 5th Avenue Plated Finial Collection..... 29
- Contempo Plated Finial Collection..... 30
- Manhattan Plated Finial Collection..... 31
- Metropolis Plated Finial Collection..... 32
- Urban Plated Finials..... 33
- Contempo Plated Tiebacks..... 33

Plated Accessories

- Corner Bracket, Elbows, etc..... 34
- Hand Crafted brackets..... 35

Signature Brackets

- Manhattan Plated brackets..... 36
- Urban Plated brackets Invisible screws..... 36
- Regal Plated brackets Invisible screws..... 37

Urban and French Rods with Returns

- Regal, Urban & Traditional Mounting plates..... 38
- Urban Slim Collection..... 39
- Urban Slim Acrylic Rods & Finials..... 40
- Urban Slim Brackets and Bypass System..... 41



plated rod styles

Rod styles available in our 13 plated finishes

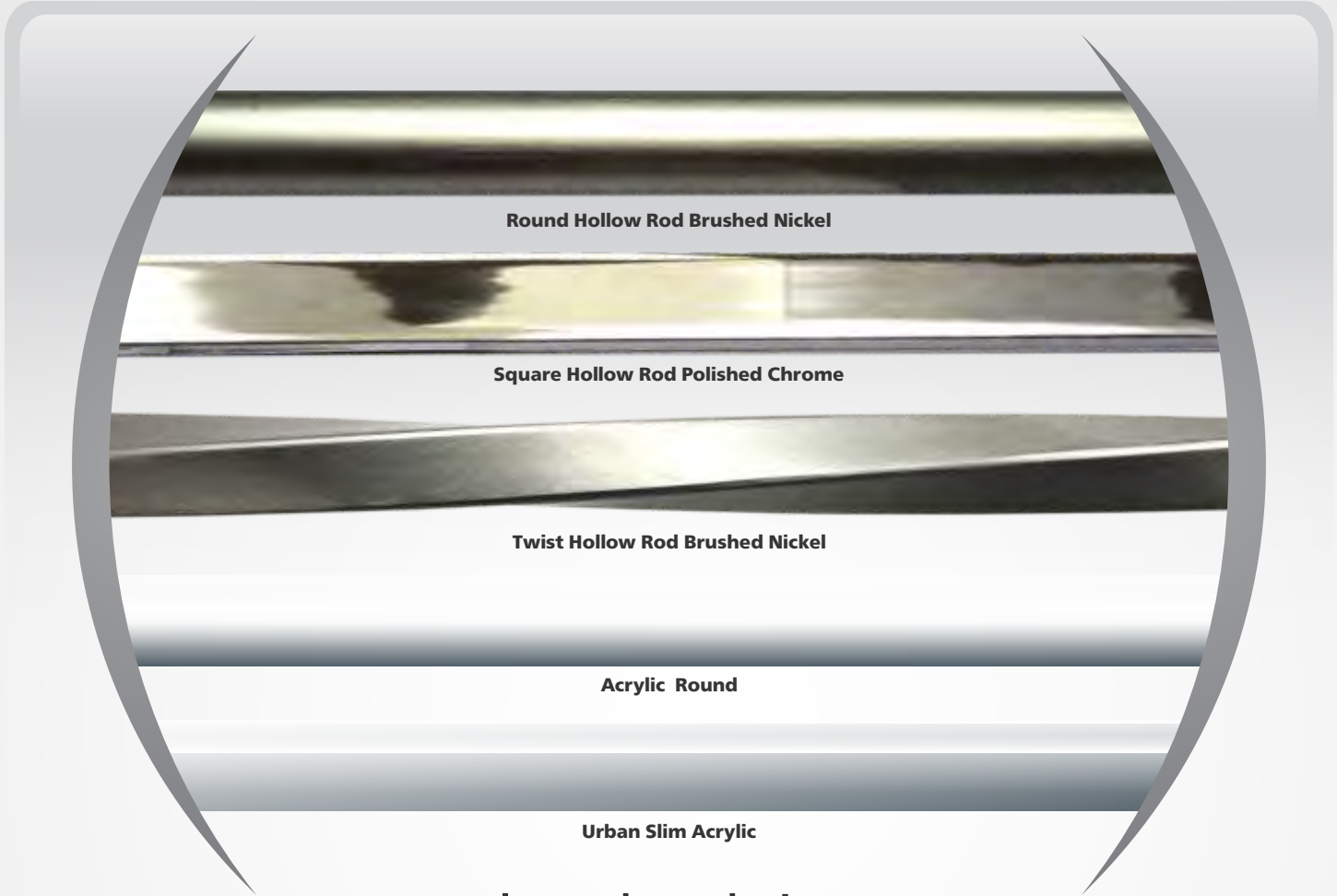

plated rod sizes

Round Rods

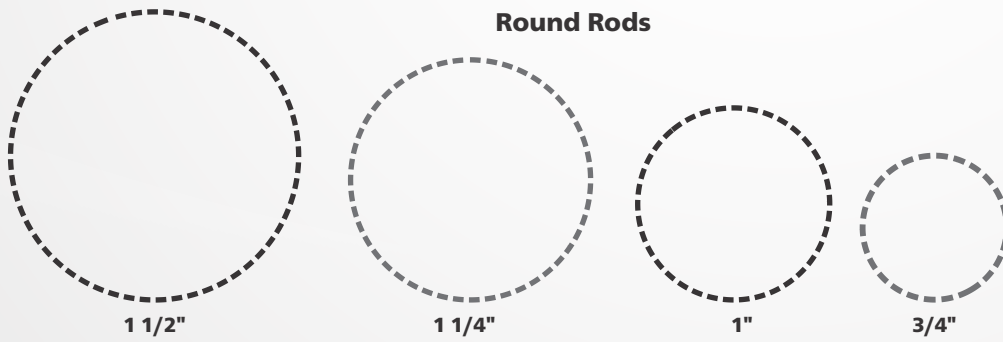

Twist Rods

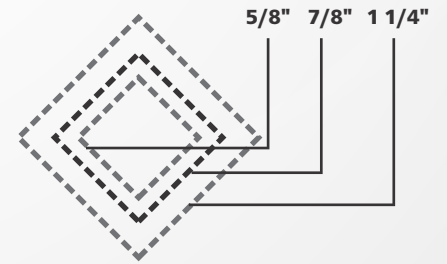

Square Rods

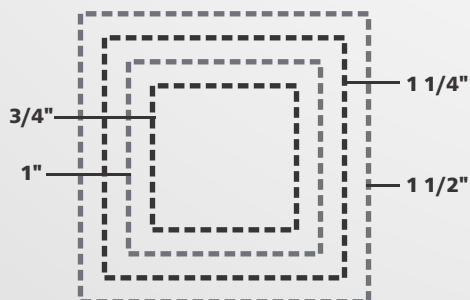

Rectangular Acrylic

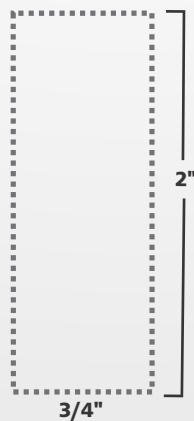

Urban Slim Rods

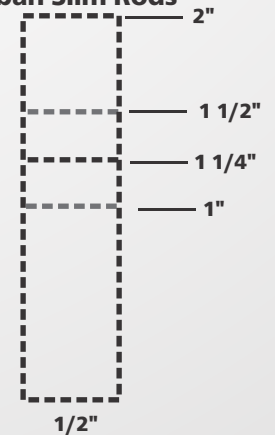

plated finials

Rods Tiebacks Accessories Batens Rings and Brackets can also be combined to design a stunning look

monaco finial collection

Create your own Design by combining up to 2 Tones from our 11 plated finishes.



M-3260
L 4" x H 1 3/4"
Brushed Onyx &
Polished Nickel



M-3261
L 3 1/4" x H 1 3/4"
Brushed Brass &
Polished Nickel



M-3262
L 2 1/4" x H 1 3/4"
Brushed Steel &
Polished Chrome



M-3263
L 3" x H 2"
Brushed Brass &
Polished Nickel



M-3264
L 3" x H 2"
Polished Nickel &
Brushed Onyx



M-3265
L 3" x H 2"
Polished Chrome &
Brushed Onyx



M-3266
L 3" x H 2"
Polished Chrome &
Polished Brass



M-3267
L 3" x H 2"
Brushed Onyx &
Polished Brass



M-3268
L 3 1/4" x H 1 1/2"
Brushed Nickel &
Polished Chrome



M-3269
L 3 1/4" x H 2 1/4"
Brushed Onyx &
Polished Brass



M-3270
L 3" x H 2"
Polished Chrome &
Brushed Onyx

M-4330
L 3 1/2" x H 1 3/4"
Brushed Brass &
Polished Nickel



M-4334
L 3" x H 2"
Polished Nickel &
Polished Brass



M-4341
L 3" x H 2"
Polished Nickel &
Polished Brass



M-4346
L 4" x H 3"
Brushed Steel &
Polished Brass



5th avenue collection *finials*

F

crystal plated finial collection



•All finials can be utilized as tiebacks.

contempo plated finial collection



plated finials

F

All Finials can be utilized as Tiebacks.

manhattan plated finial collection

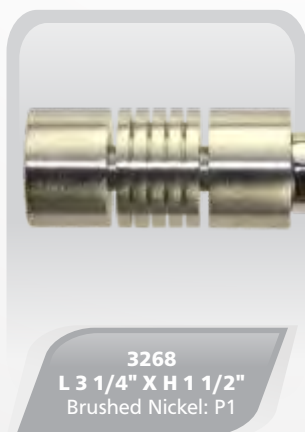
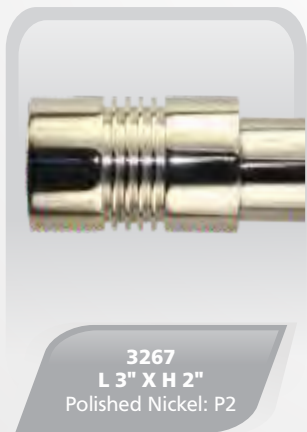
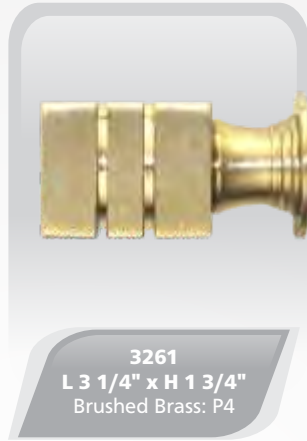

plated finials

All Finials can be utilized as Tiebacks.

metropolis plated finial collection

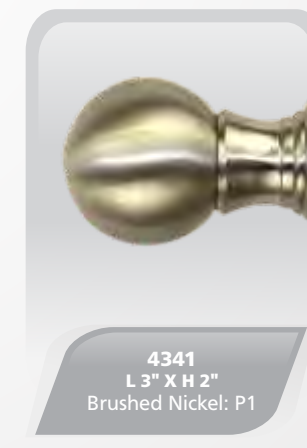
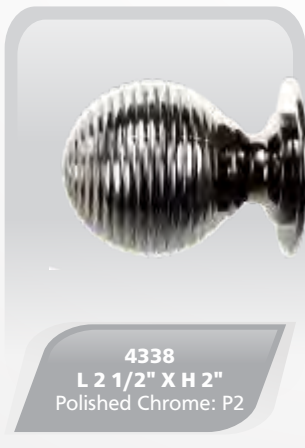
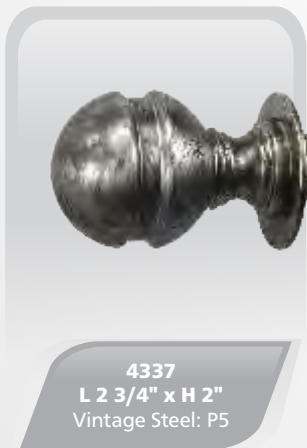
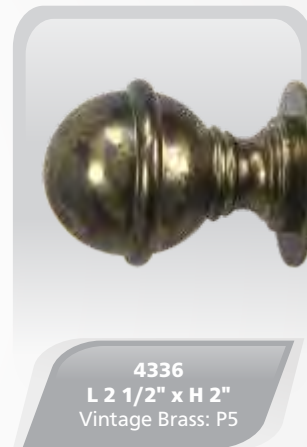
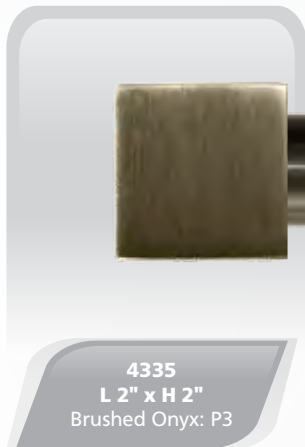
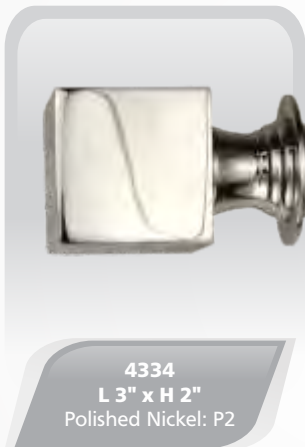
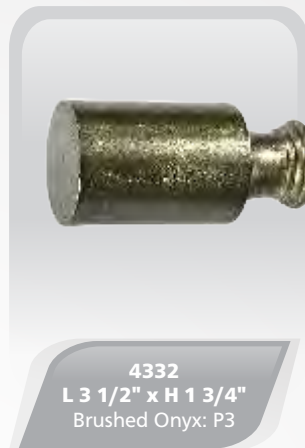
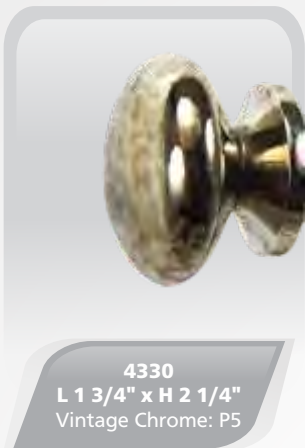

4342
L 1/2" x H 2"
Brushed Steel: P1

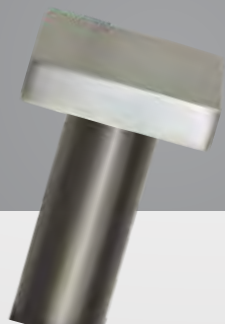

4344
L 1/2" x H 2"
Brushed Steel: P1

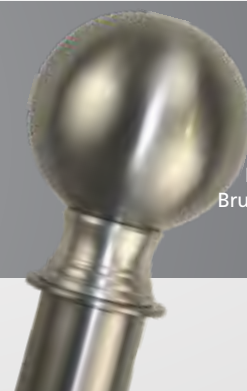

4346
L 4" x H 3"
Brushed Steel: P1

plated finials & tiebacks

F

urban plated finials

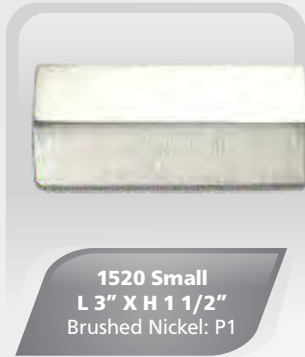

Urban Slim Finials 4680 to 4687 are available for Urban Slim Rods 1" to 2" as well as Iron Round Rods from 1" to 2" Diameter.



contempo plated tiebacks



plated accessories



1560
Swivel Elbow
Interior Fit Only
Brushed Nickel: P1



1561
Swivel Corner Bracket
Interior Fit Only
Brushed Nickel: P1



1562
Elbow
Shown as 45° Exterior Fit
Polished Chrome: P2



1563
Corner Bracket
Shown as 90° Exterior Fit
Polished Chrome: P2



1564
Half Socket
Exterior Fit Only
Brushed Onyx: P3



1565
Full Socket
Exterior Fit Only
Brushed Nickel: P1



1566
End Cap
Interior Fit Only
Brushed Onyx: P3



1566 RE
Ring End Cap
Interior Fit Only
Brushed Nickel: P1



1566 FE
Flush End Cap
Exterior Fit Only
Brushed Brass: P4



1566 SQ
Square End Cap
Interior Fit Only
Brushed Brass: P4

contempo plated batons/wands



1620
L 3" X H 5/8"
Polished Nickel: P2



1621
L 3" X H 5/8"
Brushed Onyx: P3



1568
3/4" Ball
Polished Brass: P4



1569
Plain
Polished Brass: P4



AB
Acrylic Clear
Baton 1/2"
Diameter



plated rings



1570
Smooth Round
Brushed Nickel: P1



1571
Rectangular
Polished Chrome: P2



1572
Bypass
Brushed Nickel: P1



1573
Flat Round
Polished Chrome: P2



1574
Flat Rectangular
Brushed Nickel: P1



1575
Urban Slim
Polished Chrome: P2

hand crafted plated brackets *brackets*

1550 brackets

*All Brackets are available in standard 3" & 6" projection as well as custom projections for any rod style.



*All 1550 Brackets shown in Brushed Steel: P1.

slim 1550 brackets

*All Brackets are available in standard 3" & 6" projection as well as custom projections for any rod style.



*All Slim 1550 Brackets are made out of 3/4" Wide Heavy Gauge material, shown in Brushed Brass: P4.

contempo brackets

*All Brackets are available in standard 3" & 6" projection as well as custom projections for any rod style.

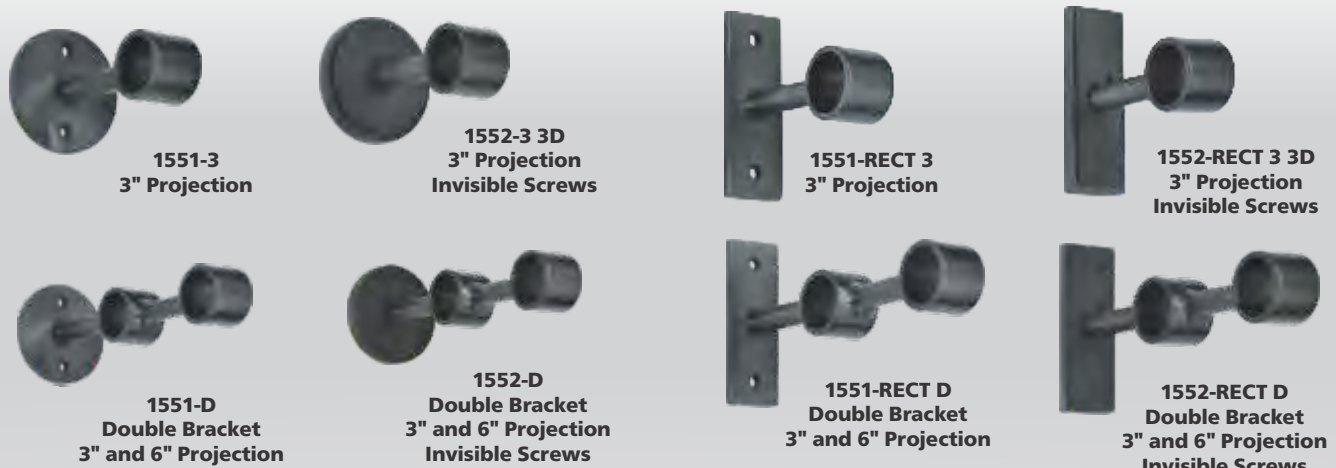

*All Contempo Bracket shown in Brushed Onyx: P3.

signature plated brackets

manhattan brackets

Brackets are available in standard 3" & 6" projection as well as custom projections for any rod style.



*Manhattan Brackets 4521 and 4522 Styles with Invisible Screws, all Brackets shown in Brushed Nickel P1.

urban brackets invisible screws

*All Brackets are available in standard 3" & 6" projection as well as custom projections for any rod style.



slim urban brackets invisible screws

*All Brackets are available in standard 3" & 6" projection as well as custom projections for any rod style.



*All Slim Urban Brackets are made out of 3/4" Wide Heavy Gauge material, shown in Brushed Steel: P1.

signature plated brackets *brackets*



regal brackets

All Regal Brackets are available as Standard 3" Projection for Round Rods from 3/4" to 1 1/2" only, with Invisible screws.

Mix and Match any Bracket Arm with any Mounting Plate to create your Personalized Bracket.



5531-TS
Shown with MP:B



5532-TS
Shown with MP:C



5533-TS
Shown with MP:A



5534-TS
Shown with MP:D



5535-TS
Shown with MP:A



5536-TS
Shown with MP:A

*All Regal Top Support Brackets shown in Polished Nickel: P2.



5531



5532



5533



5534



5535



5536

*All Regal Brackets shown with Mounting Plate "C" in Brushed Brass: P4. *MP: Mounting Plate.

regal 1550 brackets

*All Brackets are available in Standard 3" and 6" Projection as well as Custom Projections for any rod style with invisible screws.



R1550-A TS



R1550-B TS



R1550-C TS



R1550-D TS



R1550-A



R1550-B



R1550-C



R1550-D



R1550-A D
Double Bracket
3" and 6" Projection



R1550-B D
Double Bracket
3" and 6" Projection



R1550-C D
Double Bracket
3" and 6" Projection



R1550-D D
Double Bracket
3" and 6" Projection

*All Regal 1550 Brackets shown in Brushed Onyx: P3. *TS: Top Support

traditional brackets

*All Brackets are available in Standard 3" and 6" Projection as well as Custom Projections for any rod style.



15207-3
Brushed Steel: P1



15207-H
Horizontal Bracket
Brushed Steel: P1



15209-3
Brushed Steel: P1



15209-H
Horizontal Bracket
Brushed Steel: P1

urban and french plated rods with returns

regal mounting plates

All Regal Mounting Plates can be utilized with Urban and French Rods with Returns.



1590-RA
Shown with
Urban Return Rod



Urban Rod Style shown as
Single 1 1/4" Rod
Shown with
Mounting Plates
1590-RB & 1590-RA



1590-RB
Top Support Shown
with Urban Return Rod



1590-RC
Shown with
Urban Return Rod



1590-RD
Top Support
Shown with
Urban Return Rod



1590-RE
Shown with
French Return Rod



1590-RF
Top Support
Shown with
French Return Rod



1590-RG
Shown with
French Return Rod

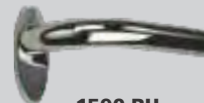

1590-RH
Top Support
Shown with
French Return Rod

*All Regal Mounting Plates shown in Polished Nickel: P2.

urban mounting plates

All Urban Mounting Plates can be utilized with Urban and French Rods with Returns.



1590-A
Shown with
Urban Return Rod



Urban Diamond Rod Style shown as
Single 1" Rod with Mounting Plates 1590-E
Vintage Steel: P5



1590-B 3D
Shown with
Urban Return Rod

Shown with
Mounting Plates 1590-D



1590-C
Shown with
French Return Rod



1590-D
Top Support
Shown with
French Return Rod



1590-E
Shown with Urban
Square Return Rod



1590-F
Top Support
Shown with
Urban Square
Return Rod



1590-G 3D
Shown with
Urban Return Rod



1590-H 3D
Top Support
Shown with
Urban Return Rod

*All Urban Mounting Plates shown in Vintage Brass: P5.

traditional mounting plates

All Traditional Mounting Plates can be utilized with Urban and French Rods with Returns.



Urban Rod Style shown as
Double 1" Rod, 3" and 6" Projection
Polished Brass: P4



1590
Mounting Plate
Brushed Onyx: P3



French Rod Style shown as
Double 1" Rod, 3" and 6" Projection
Brushed Brass: P4



1590-SQ
Shown with French
Square Rod
Brushed Steel: P1



1590-207
Shown with
French Rod
Brushed Steel: P1



1590-209
Shown with
French Rod
Brushed Steel: P1

urban slim plated collection

R

urban slim return rods

Urban Slim Return Rods are available in 1", 1 1/4", 1 1/2" and 2" .



1952-C
Shown in 1 1/4" Rod



1952-2" Urban Slim Return Rod
Shown with Mounting Plates
1952-G
Polished Brass: P4



1575
Urban Slim
Polished Chrome: P2



1952-D
Top Support
Shown in 1 1/4" Rod



1952-E 3D
Shown in 1 1/2" Rod



1952-F 3D
Top Support
Shown in 1 1/2" Rod



1952-G
Shown in 2" Rod



1952-H
Top Support
Shown in 2" Rod

*Urban Slim Mounting Plate Styles 1952-E to 1952-H with Invisible Screws shown in Polished Brass: P5.

urban slim rods

Urban Slim Rods are available on 1", 1 1/4", 1 1/2" and 2" .



1951-2" Urban Slim Rod
Shown with Finials 4644 & 4645
Brushed Nickel: P1

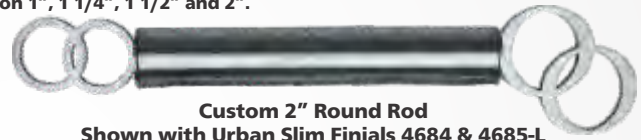

Custom 2" Round Rod
Shown with Urban Slim Finials 4684 & 4685-L
Brushed Steel: P1

urban slim finials

Urban Slim Finials 4640 to 4647 are only available for #1951-2" Urban Slim Rods.



4640
L 4 1/4" X H 2"
Polished Brass: P4



4641
L 4 1/4" X H 2"
Polished Brass: P4



4642
L 3 3/4" X H 2"
Brushed Brass: P4



4643
L 4 1/4" X H 2"
Brushed Brass: P4



4644
L 3 3/4" X H 2"
Brushed Nickel: P1



4645
L 4 1/4" X H 2"
Brushed Nickel: P1



4646
L 3 3/4" X H 2"
Brushed Onyx: P3



4647
L 3 3/4" X H 2"
Brushed Onyx: P3

Urban Slim Finials 4680 to 4687 are available for Urban Slim Rods 1" to 2" as well as Iron Round Rods from 1" to 2" .



4680
L 5 1/4" X H 3"
Polished Chrome: P2



4681
L 5 3/4" X H 2 3/4"
Polished Chrome: P2



4682
L 4 1/2" X H 2 3/4"
Vintage Steel: P5



4683
L 4 3/4" X H 3 1/4"
Vintage Steel: P5



4684
L 4 1/2" X H 2 1/2"
Brushed Steel: P1



4685-Large
L 5 1/4" X H 5"
Brushed Steel: P1



4686
L 4 1/2" X H 3 3/4"
Polished Nickel: P2



4687
L 4 3/4" X H 3 1/4"
Polished Nickel: P2

urban acrylic plated collection *urban*

acrylic rods

Urban Slim Acrylic Rods 962 to 967 are available in 3 Setting finishes: Brass, Bronze and Silver ONLY.

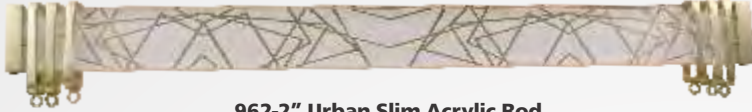

962-2" Urban Slim Acrylic Rod
Shown in Brass Setting with 508 Rings & 407-FE End Caps in Bright Brass G2.



963-2" Urban Slim Acrylic Rod
Shown in Brass Setting with 508 Rings & 407-FE Caps in Bright Brass G2.



964-2" Urban Slim Acrylic Rod
Shown in Bronze Setting with 508 Rings & 407-FE End Caps in Merlot G2.

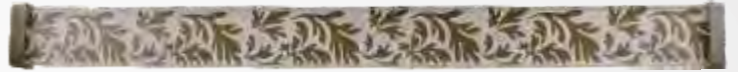

965-2" Urban Slim Acrylic Rod
Shown in Bronze Setting with 508 Rings & 407-FE End Caps in Merlot G2.



966-2" Urban Slim Acrylic Rod
Shown in Silver Setting with 508 Rings & 1566-FE End Caps in Polished Nickel P2



967-2" Urban Slim Acrylic Rod
Shown in Silver Setting with 508 Rings & 1566-FE End Caps in Polished Nickel P2



960-2" Urban Slim Acrylic Rod
Shown with Finials A4640 & A4647
Polished Nickel: P2

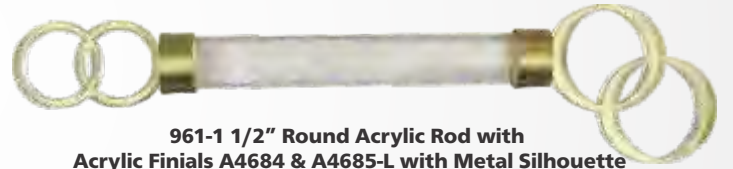

961-1 1/2" Round Acrylic Rod with Acrylic Finials A4684 & A4685-L with Metal Silhouette
Brushed Brass: P4

urban slim acrylic finials

Urban Slim Acrylic Finials A640 to A647 are available with Optional Metal Silhouette for Urban Slim Acrylic Rods only.



A4640
L 4" X H 2"
Polished Nickel: P2

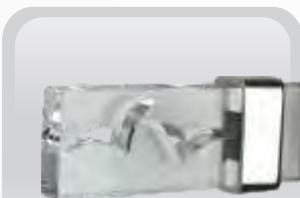

A4641
L 4" X H 2"
Polished Nickel: P2



A4642
L 3 1/2" X H 2"
Polished Nickel: P2



A4643
L 4" X H 2"
Polished Nickel: P2



A4644
L 3 1/2" X H 2"
Polished Nickel: P2

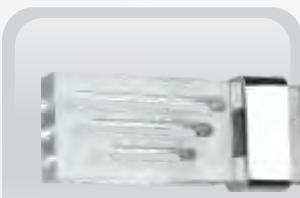

A4645
L 4" X H 2"
Polished Nickel: P2



A4646
L 3 1/2" X H 2"
Polished Nickel: P2



A4647
L 3 1/2" X H 2"
Polished Nickel: P2

urban slim plated collection

U













urban acrylic finials

Urban Slim Acrylic Finials A4680 to A4687 are available with Optional Metal Silhouette for Urban Acrylic rods and Round Iron Rods 1 1/4" to 2".

 <p>A4680 L 5 1/2" X H 3" Shown with Metal silhouette Polished Chrome: P2</p>	 <p>A4681 L 6" X H 2 3/4" Shown with Metal Silhouette Polished Chrome: P2</p>	 <p>A4682 L 4 1/4" X H 2 3/4" Brushed Brass: P4</p>	 <p>A4683 L 4 3/4" X H 3" Brushed Brass: P4</p>
 <p>A4684 L 4 1/4" X H 2 1/2" Brushed Brass: P4</p>	 <p>A4685 Large L 5 1/4" X H 5" Shown with Metal Silhouette Brushed Brass: P4</p>	 <p>A4686 L 4 1/2" X H 3 3/4" Polished Nickel: P2</p>	 <p>A4687 L 4 3/4" X H 3 1/4" Polished Nickel: P2</p>

urban slim brackets

Brackets available in Standard 3" and 6" Projection as well as Custom Projections for Urban Slim Rods only.

 <p>1955-3</p>	 <p>1955-D Double Bracket 3" and 6" Projection</p>	 <p>1956-3 3D</p>	 <p>1956-D 3D Double Bracket 3" and 6" Projection</p>	 <p>1957-3</p>	 <p>1957-D Double Bracket 3" and 6" Projection</p>
 <p>1955-TS Top Support</p>	 <p>1955-H Horizontal Bracket</p>	 <p>1956-TS 3D Top Support</p>	 <p>1956-H 3D Horizontal Bracket</p>	 <p>1957-TS Top Support</p>	 <p>1957-H Horizontal Bracket</p>

*Urban Slim Bracket styles 1956 and 1957 with Invisible Screws shown in Vintage Chrome: P5.

bypass plated system

 <p>1554-3</p>	 <p>Bypass Plated System Shown in 1" Round Rod Brushed Nickel: P1</p>	 <p>1572 Bypass Ring Brushed Nickel P1</p>	 <p>1554-U3</p>
 <p>1554-D Double Bracket 3" and 6" Projection</p>	 <p>1554-U3 3D</p>	 <p>1554-UTS 3D Top Support</p>	 <p>1554-UTS Top Support</p>
 <p>1554-H Horizontal Bracket</p>	 <p>1554-UH 3D Horizontal Bracket</p>	 <p>1554-UH Horizontal Bracket</p>	

*All Bypass Brackets shown in Brushed Steel:P1. *Urban Bypass Brackets with Invisible Screws.

Traversing Rods

- Somfy Motorized Traverse System..... 43
- Somfy Accessories 44
- Demi-Round Traverse System..... 45
- Demi-Square Traverse System..... 46
- Demi-Wood Traverse System..... 47
- Demi-Vogue Traverse System..... 47
- Demi-Urban Acrylic Traverse System..... 48
- Demi-Brackets & Accessories..... 49
- Euro-Traverse System..... 50

Wood & Resin Collection

- Wood Collection 51
- Resin Collection..... 52
- Swift Program..... 53
- Designers Tools..... 56
- Finishes..... 57

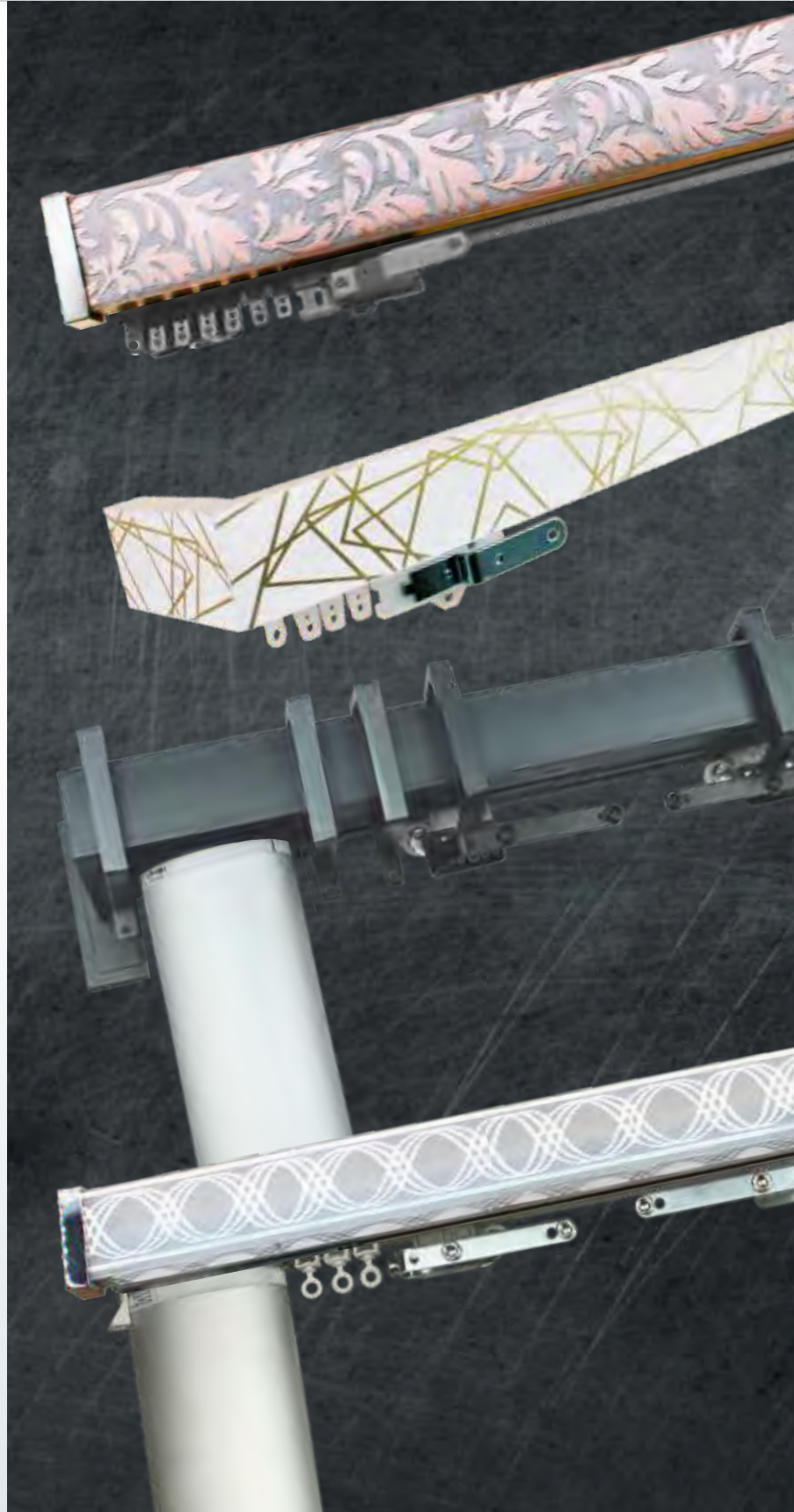

motorized traverse systems *motorized*

M

somfy motorized traverse system

Available as single and double systems as pinch pleat and ripplefold.



3005-R
Somfy Demi-Round 1 1/2"
Brushed Brass: P4



3008-S
Somfy Demi-Square 2"
Shown with Returns & Rings # 2121
Gunmetal Blue: Grp3



3021-WF
Somfy Demi-Wood Fluted 2"
Dark Walnut Stain



3024-V
Somfy Demi-Vogue 2 1/2"
Oiled Bronze: Grp2



3082-UA
Somfy Demi-Urban Acrylic 2"
Silver Setting with 1566 FE End Caps
Polished Chrome: P2



DB-5000
Somfy Demi-Bellus
Renaissance: Grp3

POWERED by
somfy.

motorized traverse systems

somfy accessories

POWERED BY:
somfy

Situo Hand-held remote controls / radio technology somfy® (RTS)



Situo 1 Arctic 1870574 **Situo 1 Pure** 1870571 **Situo 1 Natural** 1870573 **Situo 1 Iron** 1870572 **Situo 5 Arctic** 1870578 **Situo 5 Pure** 1870575 **Situo 5 Natural** 1870577 **Situo 5 Iron** 1870576 **Telis 16 Pure** 1811081 **Telis 16 Silver** 1811082

smoove wall switches



Amber Bamboo 9015026 **Walnut** 9015237 **Cherry** 9015236 **Silver** 9015025 **Black** 9015023 **Light Bamboo** 9015027 **Pure** 1811533 **4 Channel Pure** 1811748

decoflex wirefree™ wall switches (RTS)



DecoFlex White 1 Channel **DecoFlex White 2 Channels** **DecoFlex Ivory 3 Channels** **DecoFlex Ivory 4 Channels** **DecoFlex Black 5 Channels** **16 channel interface** 1810872

16 channel interface

motors

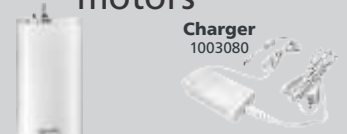

Irismo 45™ Wire Free RTS 1002353



Battery 9026476

somfy glide



Bronze **White**

ripplefold glide



Bronze **White**

decoflex wirefree™ RTS table top accesories



Table Top Black 1811051 **Table Top Silver** 1810972 **Table Top White** 181185

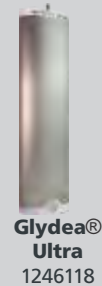

Glydea® Ultra 1246118



Irismo 35™ Mini Wire Free RTS 1003003

somfy track finishes

White **Bronze** **Silver** **Brass** **Black**

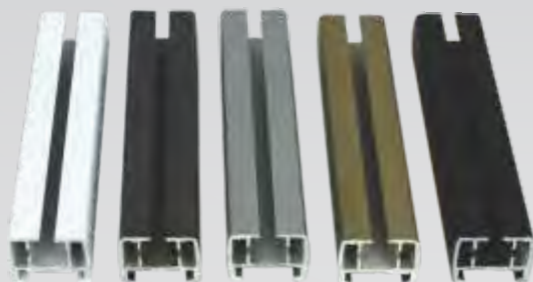

TaHoma®

1811403

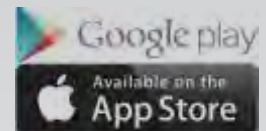

traverse rod collection *demi-round*

Available as single and double systems as pinch pleat and ripplefold.



demi-round

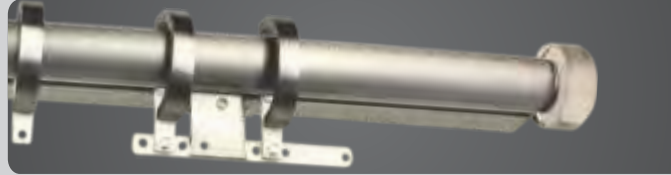
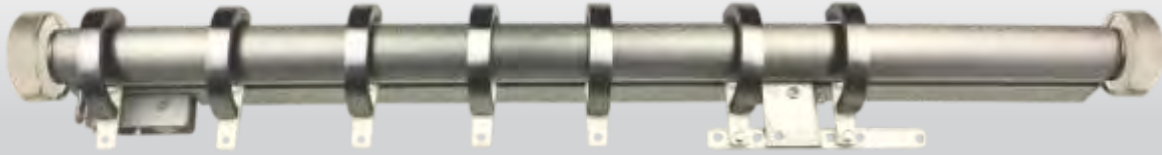

2100-R
Demi-Round Rod 1 1/4"
Shown with Rings #2117
Brushed Nickel: P1



2102-RD
Demi-Round
Double 2" & 1"
Vintage Steel: P5

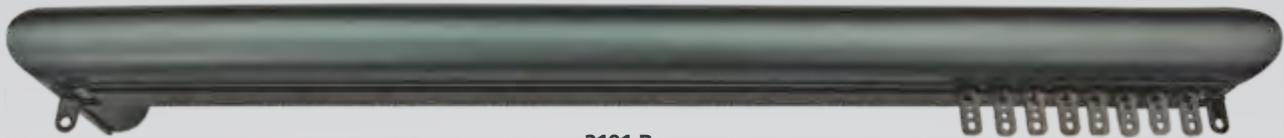
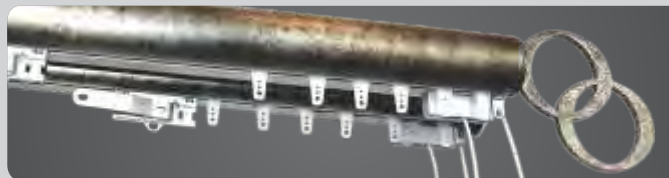

2101-R
Demi-Round 1 1/2"
Shown with Returns
Gunmetal Blue: Grp 3



2125-Miter Returns
with Flush Mounting Plate
(Round Demi-Rods only)



2125-Miter Returns
with 926-RE Mounting Plate

demi-round rings

All demi-rings with ball bearing glides.

2115
Smooth Round
Olive: Grp3



2116
Hammered Round
Oxide: Grp2



2117
Flat Round
Brushed Nickel: P1





traverse rod collection *demired*

Available as single and double systems as pinch pleat and ripplefold.

demi-square



2103-S
Demi-Square Rod 1 1/4"
Shown with Rings # 2121
Polished Nickel: P2

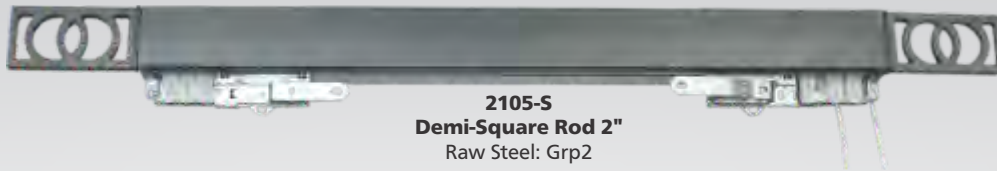

2105-S
Demi-Square Rod 2"
Raw Steel: Grp2

demi-square rings

All demi-rings with ball bearing glides.

2119
Smooth Square
Mystique: Grp2



2120
Hammered Square
Black Nickel: Grp2



2121
Flat Square
Brushed Onyx: P3



demi-round & demi-square return rod regal mounting plates

Available for Somfy & Demi-Traverse Rods.



HP:D926-RA
P: D1590-RA
Polished Nickel: P2



HP:D926-RB
P: D1590-RB
Top Support
Gunmetal Blue: Grp3



HP: D926-RC
P: D1590-RC
Polished Nickel: P2



HP: D926-RD
P: D1590-RD
Top Support
Gunmetal Blue: Grp3



HP: D926-RE
P: D1590-RE
Polished Nickel: P2



HP: D926-RF
P: D1590-RF
Top Support
Gunmetal Blue: Grp3



HP:D926-RG
P: D1590-RG
Polished Nickel: P2



HP: D926-RH
P: D1590-RH
Top Support
Gunmetal Blue: Grp3

demi-round & demi-square return rod urban mounting plates



HP: D926-C
P: D1590-C
Polished Brass: P4



HP: D926-E
P: D1590-E
Oiled Bronze: Grp2



HP: D926-G 3D
P: D1590-G 3D
Top Support
Gunmetal Blue: Grp3



HP: D926-D
P: D1590-D
Top Support
Polished Brass: P4



HP: D926-F
P: D1590-F
Top Support
Oiled Bronze: Grp2



HP: D926-H 3D
P: D1590-H 3D
Top Support
Gunmetal Blue: Grp3

traverse rod collection *demi-rod*



demi-wood

Available as single and double systems as pinch pleated and ripplefold.



2200-WS
Demi-Wood 2" Smooth
Dark Walnut Stain



2201-WF
Demi-Wood 2" Fluted
Shown with Rings #2230
Noir: Grp3



2200-WS
Demi-Wood 2" Smooth With #2125 Miter Returns
White: Grp2

demi-wood rings

All rings with ball bearing glides.



2230 Smooth
Oiled Bronze: Grp2

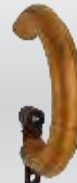

2232 Fluted
Custom Finish Grp: 4

demi-vogue

Available in Wood 2 1/2" Height



2223-V Demi-Vogue with Accent #1
Dark Walnut: Stain



Accent #1
Polished Brass: P4



2223-V Demi-Vogue with Accent #2
Mahogany: Stain



Accent #2
Brushed Steel: P1



2223-V Demi-Vogue with Accent #3
White: Grp 2



Accent #3
Brushed Brass: P4



2224-V Demi-Vogue
Oiled Bronze: Grp 2



2225-V Demi-Vogue
Black Nickel: Grp 2



2226-V Demi-Vogue
Dark walnut: Stain



2240-V Demi-Vogue with 1566-FE End Caps
Walnut: Stain



2241-V Demi-Vogue with 1566-FE End Caps
Copper Vecchio: Grp 2



2242-V Demi-Vogue with 1566-FE End Caps
Black Nickel: Grp 2



2243-V Demi-Vogue with 1566-FE End Caps
Old Bronze: Grp 2



2244-V Demi-Vogue with 1566-FE End Caps
Dusty Gold: Grp 2



2245-V Demi-Vogue with 1566-FE End Caps
Gold Vecchio: Grp 2



2244-V Demi-Vogue
With Miter Returns

traverse rod collection *demi-bellus*

demi-urban acrylic

2" Demi-Urban Acrylic is available in 3 Setting finishes: Brass, Bronze & Silver ONLY.



2280-UA 2" Demi-Urban Acrylic
Shown with 1566-FE
Shown in Bronze Setting

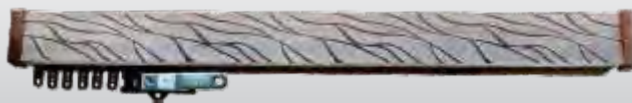

2281-UA 2" Demi-Urban Acrylic
Shown with 1566-FE
Shown in Bronze Setting



2282-UA 2" Demi-Urban Acrylic
Shown with 1566-FE
Shown in Silver Setting



2283-UA 2" Demi-Urban Acrylic
Shown with 1566-FE
Shown in Silver Setting



2284-UA 2" Demi-Urban Acrylic
Shown with 1566-FE
Shown in Brass Setting



2285-UA 2" Demi-Urban Acrylic
Shown with 1566-FE
Shown in Brass Setting

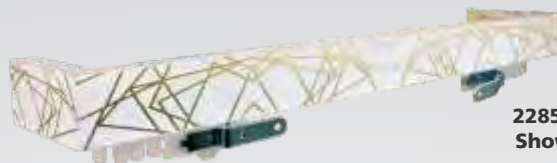

2285-V Demi-Urban Acrylic
Shown with Miter Returns

demi-bellus

Available as single and double systems as pinch pleat and ripplefold.



DB-5000 H-4"
(Shown with 3 1/2" Returns)
Renaissance: Grp3



DB-5003 H-3 1/2"
(Shown with Returns)
White: Grp2



DB-5001 H-3 1/2"
(Shown with Finial 05 Large)
Plume: Grp3



DB-5004 H-3 1/2"
(Shown with Finials 1727)
Enigma: Grp2



DB-5002 H-2 1/2"
(Shown with 3 1/2" Returns)
Cava: Grp2



DB-5005 H-2 1/2"
(Shown with Finial 133-3")
Oiled Bronze: Grp2

*While Supplies Last.



traverse rod collection

demi-brackets

Universal demi-brackets for all demi-motorized and demi-traverse systems.



*All Universal demi-brackets shown in Brown: Grp 1. *Demi-brackets 2111 & 2112 are made with Invisible Screws.

demi-rod connector covers



demi tracks and glides



euro-traverse rod collection *traverse*

euro-traverse

Euro-traverse Full Rod (not corded) Systems are available in Round and Square 1 1/4", 1 1/2" and 2".



2151 Euro-Round 1 1/2"
Shown with Finials NC-1506 Small with Rings # 2115
Brushed Onyx: P3



2154 Euro-Square 1 1/4"
Shown with Finials 62
Black Nickel: Grp2

euro brackets

Brackets are available in Standard 3" Projection for Single Rod and 3" & 6" for Double Rods.



2160-3
Merlot: Grp2



2160-TS
Top Support
Merlot: Grp2



2161-3 3D
Shown for
Square Rod
Vintage Steel: P5



2161-TS 3D
Top Support
Shown for
Square Rod
Vintage Steel: P5



2162-3
Merlot: Grp2



2162-TS
Top Support
Merlot: Grp2



2160-D
Double Bracket
Merlot: Grp2



2161-D 3D
Double Bracket
Shown for Square Rod
Vintage Steel: P5



2162-D
Double Bracket
Merlot: Grp2

*Euro-Brackets 2161 & 2162 are made with Invisible Screws.

euro rings

All rings with ball bearing glides.

round rings



2115
Smooth Round **2117**
Flat Round

square rings



2119
Smooth Square **2121**
Flat Square

glide colors



ring glide colors
Bronze White Black

ripplefold glide



White Bronze

wood collection

Collection available for 1 3/8" & 2" Wood Poles as well as for Metal Rods.



Wood Pole Smooth

wood poles



Wood Pole Fluted

wood finials



1800
Light Walnut: Stain

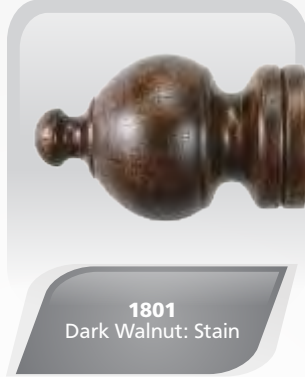

1801
Dark Walnut: Stain



1802
White: Grp 2



1803
Gold Vecchio: Grp2

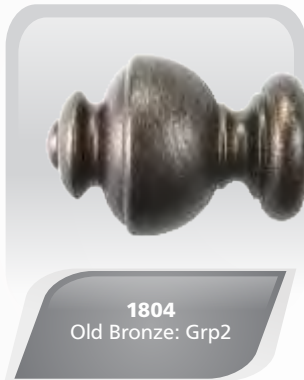

1804
Old Bronze: Grp2



1805
Old Country: Grp3

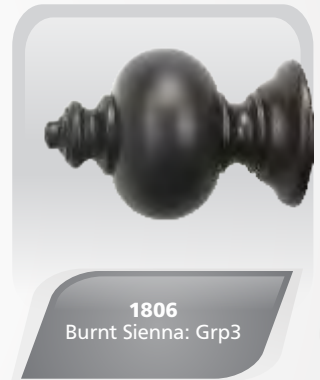

1806
Burnt Sienna: Grp3

wood tieback



1810
U-shaped
Shown with
Finial 1803
Dark Walnut:
Stain

wood accessories



1830
Half Socket
Custom Color: Grp 4



1831
Full Socket
Rusted Black: Grp3



1832
End Cap
Custom Color: Grp 4



1833
Swivel Elbow
Dark Walnut: Stain

wood brackets



1820
4" Projection
Mahogany: Stain



1821
4" Projection
Verdy Vecchio: Grp2



1821
7" Projection
Enigma: Grp2

wood rings



1840 Fluted
Gold Vecchio: Grp2



1841 Smooth
Burnt Sienna: Grp 3

Baton 1835
Custom Color:
Grp 4



resin finials



1720
L 4 1/2" x H 3 3/4"
Oiled Bronze: Grp2



1721
L 5" x H 4"
Dark Umber: Grp2

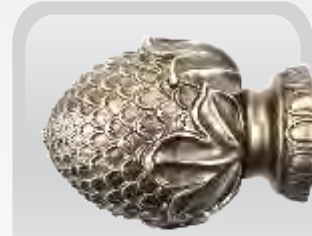

1722
L 5 1/4" x H 3 3/4"
Heirloom: Grp2

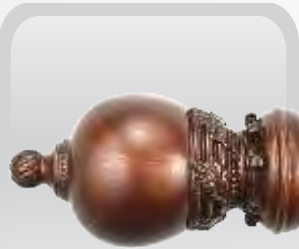

1723
L 6" x H 3 1/4"
Merlot: Grp2



1724
L 4 3/4" x H 3"
Black Nickel: Grp2



1725
L 5" x H 3 1/2"
Cava: Grp2



1726
L 7" x H 3 1/2"
Mystique: Grp2



1727
L 6" x H 3 1/2"
Radiant Gold: Grp2

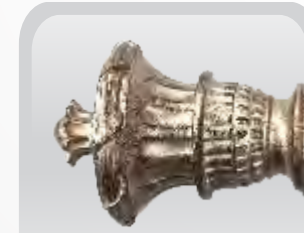

1728
L 5 1/2" x H 3 3/4"
Plume: Grp3

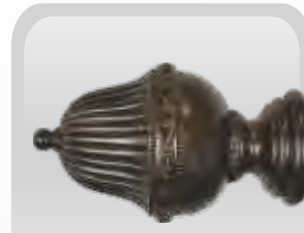

1729
L 6" x H 3 3/4"
Old Bronze: Grp2

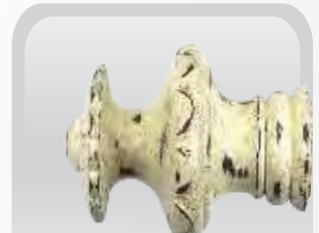

1730
L 4 3/4" x H 4"
Old Country: Grp3



1731
L 6" x H 3 3/4"
Verdy Vecchio:
Grp3



1732
L 4 3/4" x H 3 1/4"
Burnt Sienna:
Grp3

resin brackets



1750
For 2" Wood Poles
H 5 1/2" L 6" x P 4"
Verdy Vecchio: Grp3



1750 D
For 1 3/8" and 2"
Wood Poles
H 5 1/2" L 9 1/2" x P 3" and 7"
Verdy Vecchio: Grp3



1751
For 2" Wood Poles
H 5 1/2" L 6" x P 4"
Renaissance: Grp3



1751 D
For 1 3/8" and 2"
Wood Poles
H 5 1/2" L 9 1/2" x P 3" and 7"
Renaissance: Grp3

resin tiebacks



1760
5" Diameter
Renaissance: Grp3



1761
5" Diameter
Old Country: Grp3



1762
5" Diameter
Vintage: Grp3



1763
4 1/2" Square
Plume: Grp3



1764
4 1/2" Square
Burnt Sienna: Grp3

resin end caps



1780
3 1/2" Diameter
Old Country: Grp3



1781
3 1/2" Diameter
Old Bronze: Grp2



1782
3" Diameter
Plume: Grp3

resin rings



1790
3/4" Thickness
2 3/4" ID Only
Old Bronze: Grp2



1791
3/4" Thickness
2 3/4" ID Only
Plume: Grp3



1792
3/4" Thickness
2 3/4" ID Only
Renaissance: Grp3

cornices & crowns

cornices



2000
Panel L 27 1/4" X H 10 3/4"
Enigma: Grp2



2010
Cornice Return
Enigma: Grp 2



2001
Panel L 27 1/2" X H 10 1/2"
Dark Umber: Grp2



2002
Panel L 27" X H 10 1/2"
Oxide: Grp2



2003
Panel L 29" X H 7 3/4"
Custom Color: Grp4

crowns



1300
L 26 1/2" X H 15"
Renaissance: Grp3

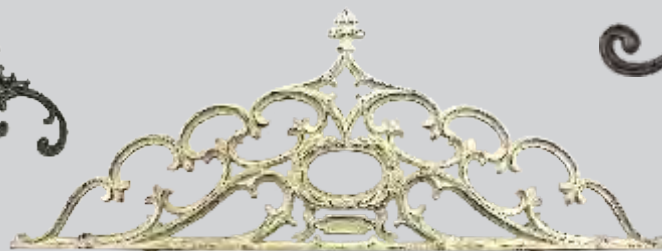

1302
L 37" X H 13"
Old Country: Grp3



1301
L 23" X H 7 1/2"
Old Bronze: Grp2

1303
L 40" X H 15 1/2"
Enigma: Grp2



1305
L 33 1/2" X H 9"
Tarnished Brown:
Grp3



1304
L 38" X H 20"
Vintage: Grp3



1306
L 36" X H 9"
Verdy Vecchio:
Grp3

decorative rods *decorative*



artisan rods

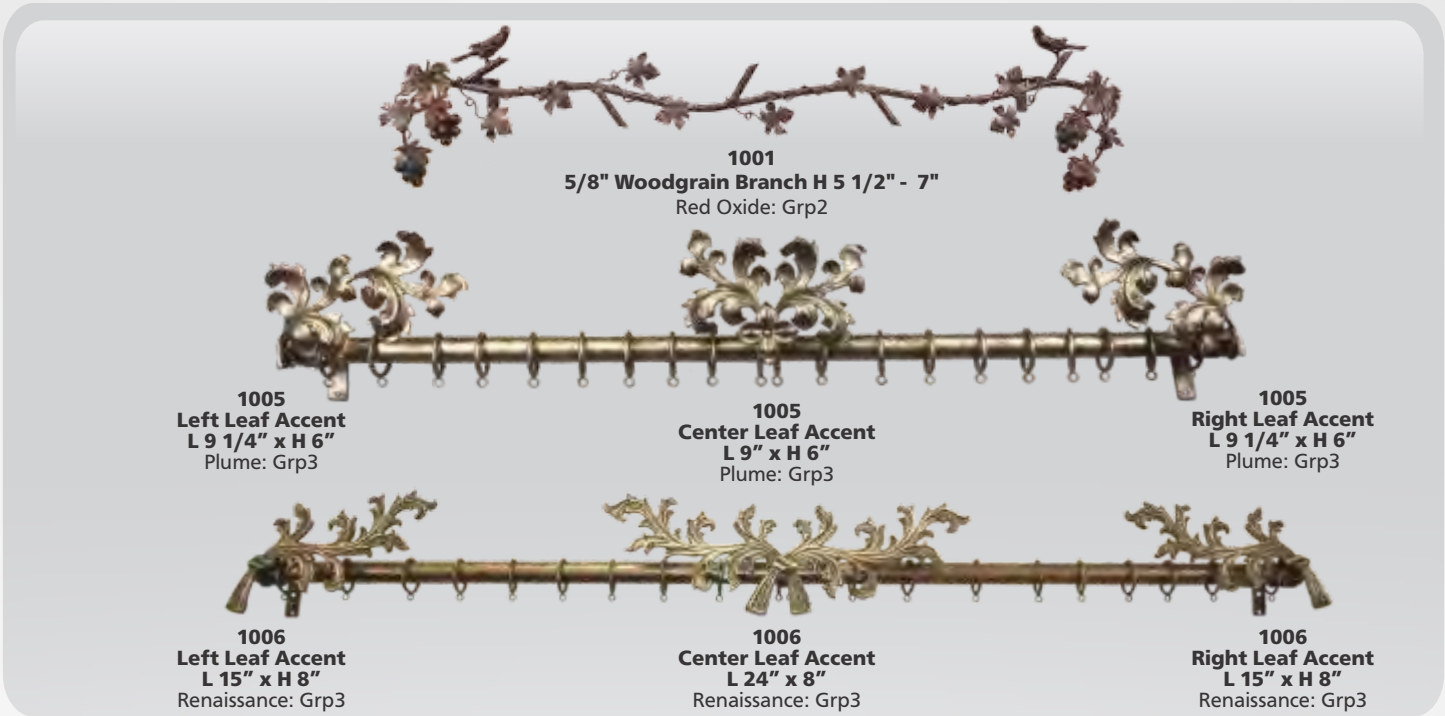

scrolls



swing arms



swift program

Available in 1" and 1 1/4" Round Hollow Rods only.

Available in 1" Round Hollow Rod only.



33
L 1 3/4" x H 2 1/4"
Merlot: Grp2



35
L 2 1/4" x H 1 1/2"
Black Nickel: Grp2



803
L 2 1/8" x H 2"
Polished Chrome: P2



805
L 2 1/4" x H 2 1/4"
Polished Chrome: P2



37
L 2 1/4" x H 1 1/2"
Copper Vecchio: Grp2



62
L 2 1/4" x H 1 3/4"
Mystique: Grp2



806
L 2 1/4" x H 2 1/4"
Polished Chrome: P2



811
L 3/4" x H 1 3/4"
Polished Nickel: P2



331
L 2 3/4" x H 2"
Dark Umber: Grp2



134-2"
2" Diameter
Gold Vecchio: Grp2



3262
L 2 1/4" x H 1 3/4"
Brushed Nickel: P1



3268
L 3 1/4" x H 1 1/2"
Brushed Nickel: P2



42
L 1 1/2" x H 1 7/8"
Gold Vecchio: Grp2



407-A Large
L 5/8" x H 2"
Gold Vecchio: Grp2



1566-A Small
L 5/8" x H 1 3/4"
Polished Chrome: P2



1542
L 1 1/2" x H 1 7/8"
Brushed Onyx: P3



Bracket 304-3
3" Projection
Black: Grp1

Bracket 304-D
3" and 6" Projection
Black: Grp1

Ring 500
Round Smooth
Black: Grp1



Bracket 1550-3
3" Projection
Brushed Nickel: P1

Bracket 1550-D
3" and 6" Projection
Brushed Nickel: P1

Ring 1570 Round Smooth
Brushed Nickel: P1

Next Day Finishes

3-Day Delivery Finishes

3-Day Delivery Plated Finishes

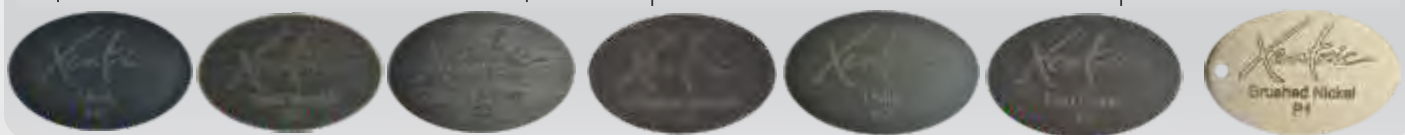

Black
Grp 1

Gold Vecchio
Grp 2

Old Bronze
Grp 2

Copper Vecchio
Grp 2

Oxide
Grp 2

Red Oxide
Grp 2

Brushed Nickel
P1

designer's tools *designer*

S



#850
platinum display



#851
gold display



#852
designer presentation case



#859
round rod set



#860
square rod set



#861
round ring set



#862
square ring set



#853
designer platinum package



#854
designer gold package



#857
plated finish selector



#855
designer silver package

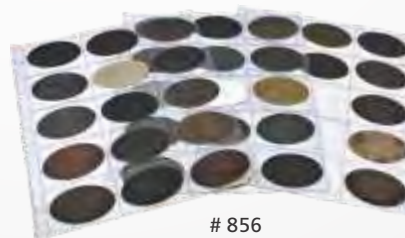

#856
hand painted/stains
finish selector



#858
individual finish sample



#863
Custom finish sample

measurement guide

finial

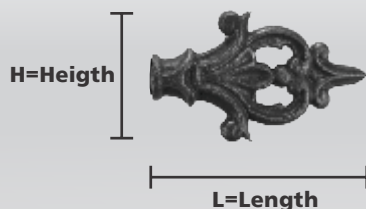

bracket

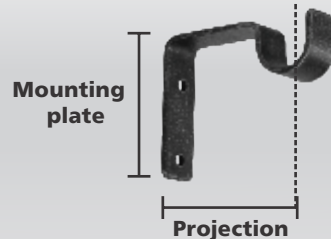

ring

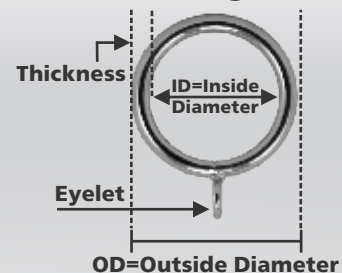

All colors are hand-made and variations may occur, please refer to Xentric's Finish selector before ordering.

group 1



Black



Brown



Light Brown

group 2



Aged Brass



Black Nickel



Bright Brass



Cava



Copper Vecchio



Dark Steel



Dark Umber



Dusty Gold



Enigma



Gold Vecchio



Heirloom



Merlot



Mystique



Oiled Bronze



Old Bronze

finishes *brushes*

F

All colors are hand-made and variations may occur, please refer to Xentric's Finish selector before ordering.

group 2



Oxide



Radiant Gold



Red Oxide



Raw Steel



Satin Bronze



Satin Silver



White

group 3



Burned Brass



Burnt Sienna



Flare



Gunmetal Blue



Noir



Old Country



Olive



Plume



Renaissance

finishes *finishes*

All colors are hand-made and variations may occur, please refer to Xentric's Finish selector before ordering.

group 3



Rusted Black



Rustic



Tarnished Brown



Verdy Vecchio



Vintage

plated finishes

Plated 1



Brushed Nickel



Brushed Steel



Polished Chrome



Polished Nickel

Plated 2

Plated 3



Brushed Onyx

Plated 4



Brushed Brass



Polished Brass

Plated 5



Vintage Brass



Vintage Chrome



Vintage Rubbed Bronze



Vintage Steel

finishes

stains



Dark Walnut



Light Walnut



Mahogany

Custom Color Matching Available

Custom Gold & Silver Leaf Finishes Available



Ring used as Reference for color Matching

*custom paneling services available in:
Stainless Steel, Iron, Acrylic & Wood.*

Shown as Room Dividers



Call us for a quote...

Shown as Custom Displays



Xentric
CUSTOM DRAPERY HARDWARE

Established 2005

www.myxentric.com

1 (866) 4-Xentric
1 8 6 6 4 9 3 6 8 7 4 2